



COOLWHIP
CAMPER CONVERSIONS

YOUR INSTALLATION INSTRUCTIONS

T4/T5/T6 FLAT PACK FURNITURE



INSTALLATION INSTRUCTIONS

STOP & READ

Please ensure you briefly read over this instruction manual before attempting to assemble and fit your units. Once you have an understanding of the process, please then read and follow each page step by step, failure to do this can result in mistakes and the process taking much longer.

Please note some pictures contain our Premium furniture, however all principles of the instructions remain the same. If you have the T4, T5/6 Low level or T5/6 slim line variant kit, these instructions may differ slightly to your furniture. The slimline is the exact same just in slim form. The low level is also the same, however includes two worktops and two top lockers to accommodate the half height rear wardrobe design. All the information you need is in this manual.

Our integrated floor design allows you to build the units in the comfort of a workshop or garage then simply lift them into the van. This allows for electrical work to be carried out before the units have been fitted. Take care when lifting the units, and never lift from the floor alone as you may snap the join.

These instructions have been broken down into two manuals, the first phase is the construction of the furniture, the second is the electrical and appliance installation. Please ensure you follow in order.



CONTENTS

3-5	Overview
6-16	T Trimming
17-22	Hanging doors
23-26	Drawer assembly
27-28	Floor assembly
29-45	Wardrobe assembly
46-52	Assembly
53-57	Folding table
58-59	Worktop
60-62	Top Locker
63-64	Splashback

THE PROCESS

Read instructions and
prepare work space and tools

Tambour doors



The floor



T Trimming



Hang all doors and fit catches



Assemble and fit



T TRIMMING

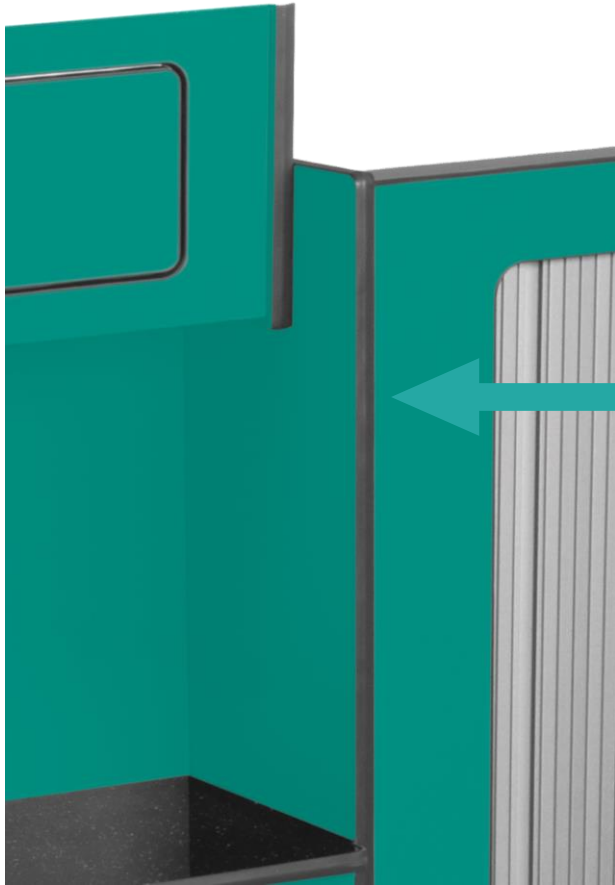

TOOLS

- Mallet
- Stanley knife
- Curved Stanley knife
- Mitre shears

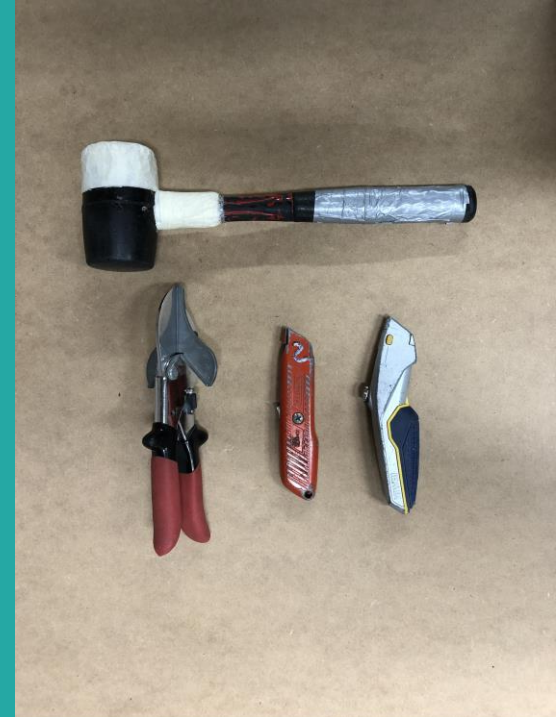

QUICK OVERVIEW

Starting the Trim

Trimming corners

Ending the join

Removing Trim from hinge holes

Tips and hints

Do not T trim perimeter of wardrobe front, wardrobe upright (L) and wardrobe upright (R) until slide 51

Do not T trim the floor until slide 36



STARTING THE TRIM



Cut the trim square before starting every piece



Ensure the lip is on the surface denoted by the piece sticker



Start and finish on the black line

CORNERS



Keep the Trim tight
to avoid gaps



Use the inside of the mallet
to trim door apertures*

CORNERS

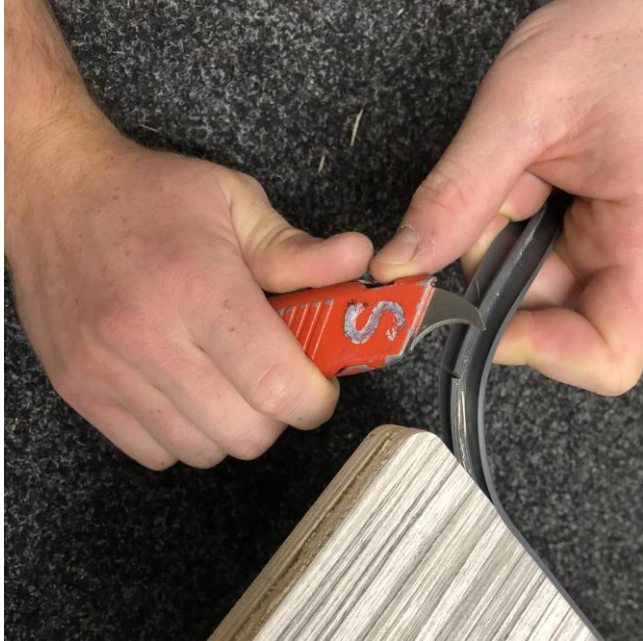

Remove the inner trim to avoid bobbled corners

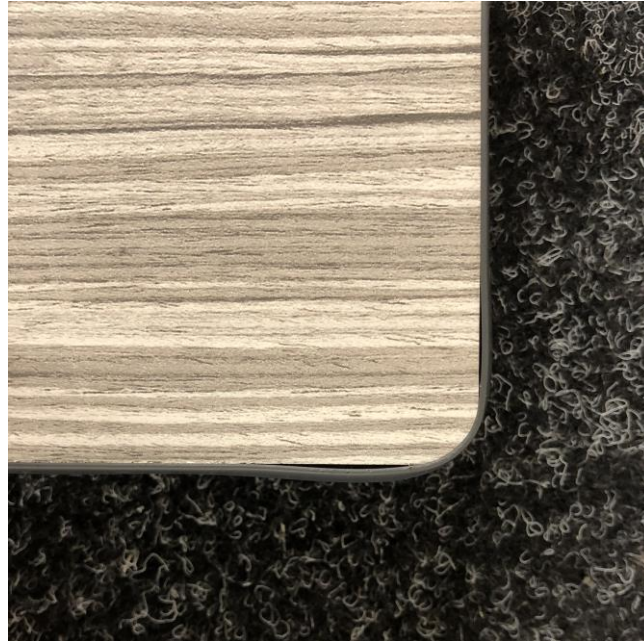

ENDING THE TRIM



Mark and cut the Trim a few (mm) past the start point

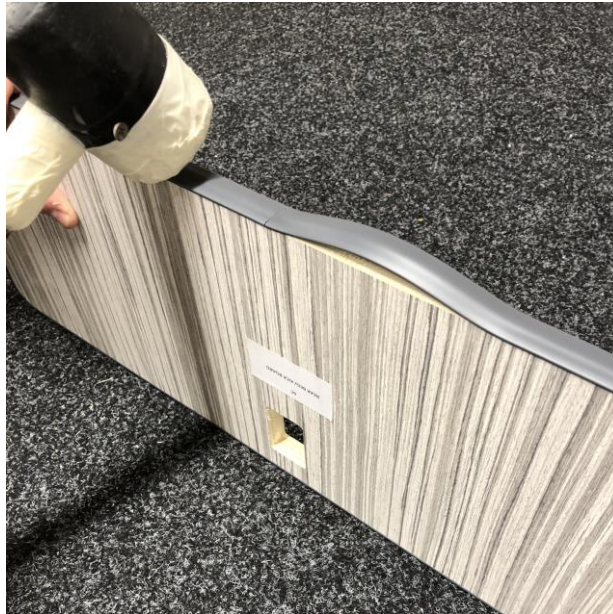

Butt the two Trims together



Mallet the join flush.

ENDING THE TRIM



Where there is no join simply cut the edge straight with a Stanley

REMOVE THE HINGE



Remove the inner Trim from the hinge hole to allow the hinge to sit flush. Failure to do this will result in bulging

TOP LOCKER



Leave some excess trim on the top right of the Top locker face, this will make sense later on

FRIDGE PODS

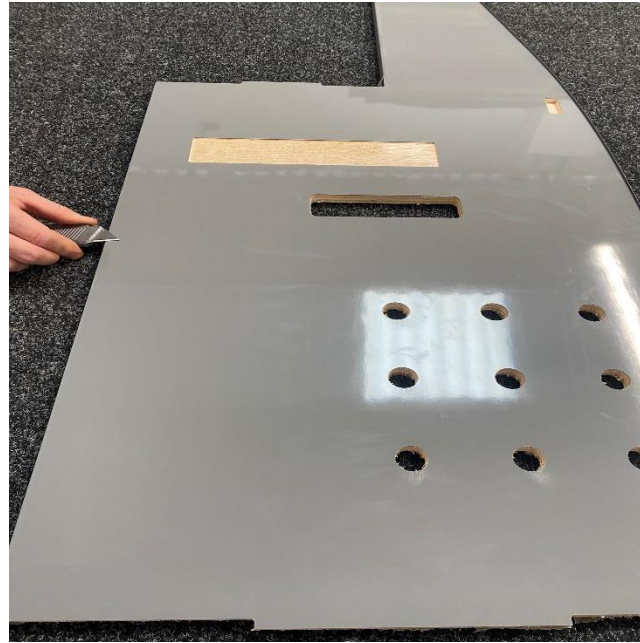
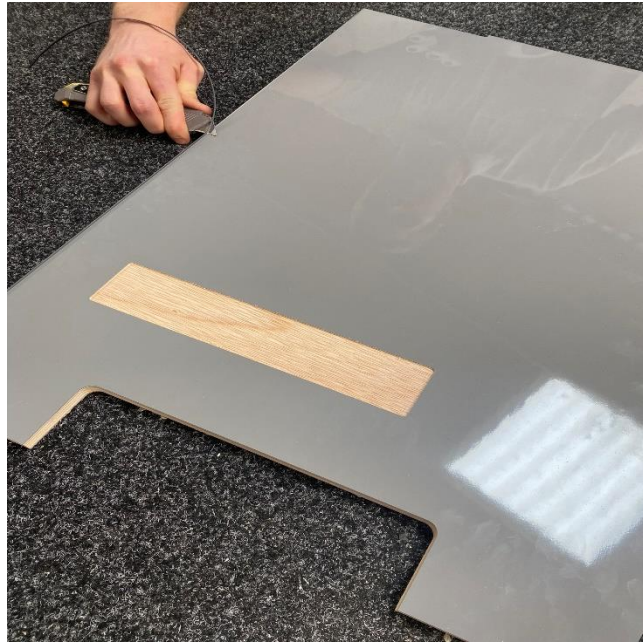

Remove the rear trim lip from both fridge pods

TIPS AND HINTS



Always keep the trim taught to avoid gaps and bobbles



Always hit down onto a surface, use the edge of a bench if necessary



Heat the trim to stretch and manipulate

HANGING DOORS

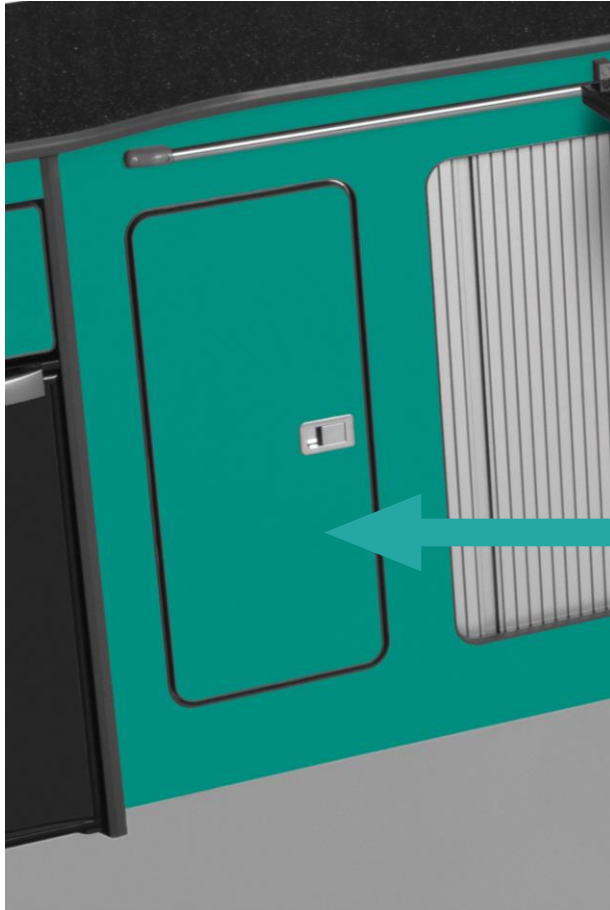

TOOLS

- Drill Driver
- Stanley knife
- Cross head Screw driver



HANDLES

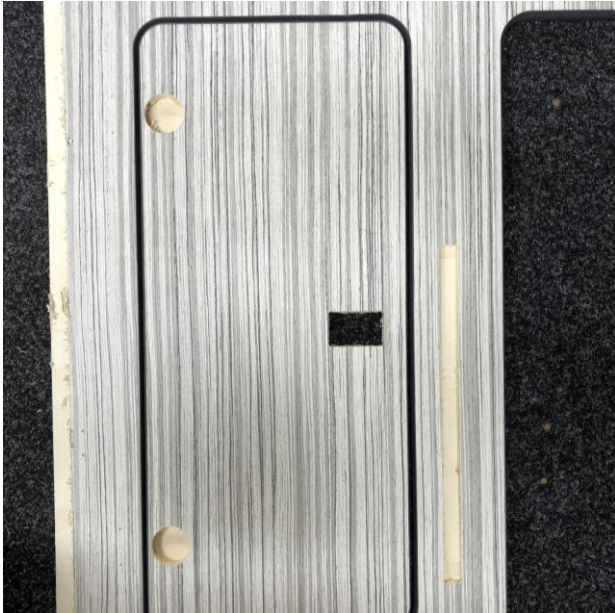

Place the correct door into the correct aperture ensuring the door is orientated correctly



Place the handle catch into the hole



Using 16mm screws, fix the back of the catch into place ensuring the catch is straight

HINGES



Fix the hinges to the door only using 16mm screws and the pilot holes provided

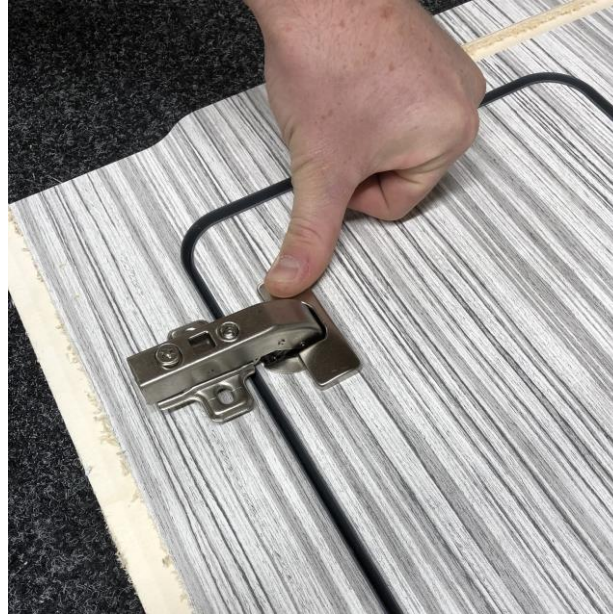

Clip on the cover plates



Turn the adjustment all the way to the rear before fixing to the aperture

(CONT.)

HINGES



Remove wide screws and replace with 16mm screws to fit the plate to the aperture

HORIZONTAL
ADJUSTMENT

OVERLAY
ADJUSTMENT

CLIP-ON
MOUNT

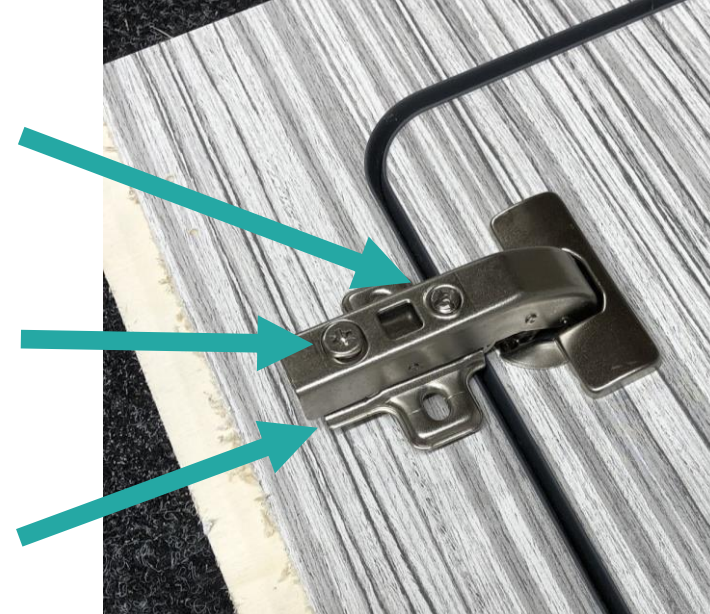

Once both hinges are fitted, adjust the door to fit flush with equal spacing

STRIKE PLATE



Mark out the width of the strike plate on the door and the aperture parallel to the catch using a Stanley knife



Remove the trim lip from the door and the aperture allowing the strike plate to sit flush onto the wood, then fit using 2 x 16mm screws*

HANGING DOORS

CHECK & MAKE SURE...

The doors sit flush and open and shut correctly

Now follow the same process of hanging all the doors before continuing to page X

SOFT CLOSE DRAWER ASSEMBLY



(CONT.)

SOFT CLOSE DRAWER ASSEMBLY



Attach the mounting clips



Fit the drawer rear using
16mm screws



Fit the drawer base using
16mm screws, ensure the
base is flush to avoid gaps

(CONT.)

SOFT CLOSE DRAWER ASSEMBLY



Fit the drawer face catch

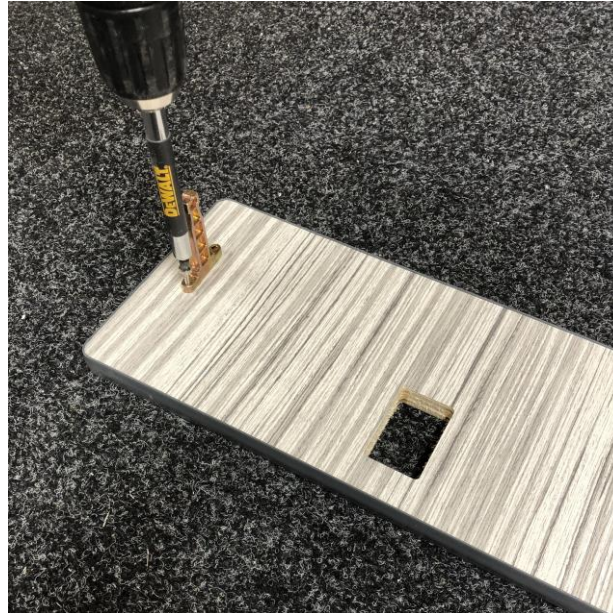

Screw the drawer face mounts into the pilot holes with the 4 x large head screws provided with the drawer box



Clip the face into the side runners

FRIDGE POD ASSEMBLY

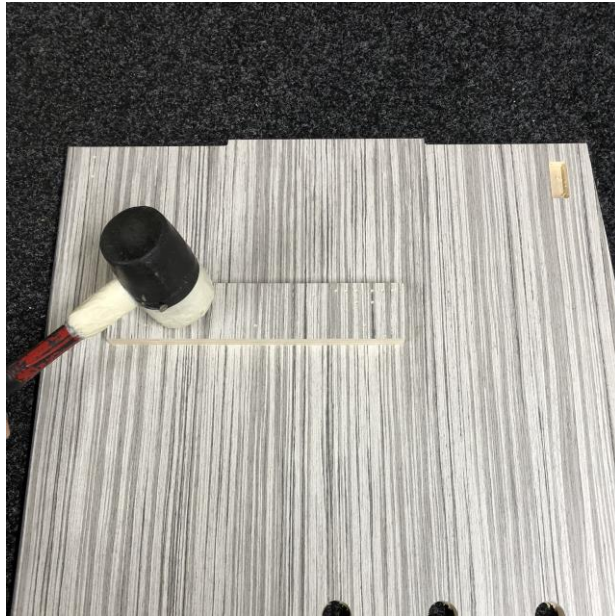

Ensure the block sits flush before screwing, some sanding may be required

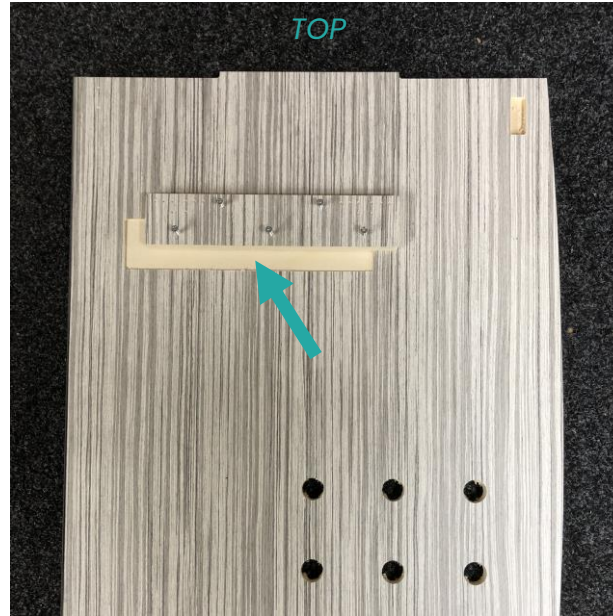

Align the Drawer fixing blocks and fit using 5 x 25mm screws into the same pilot holes as the picture, do not counter sink far enough to go through the both material

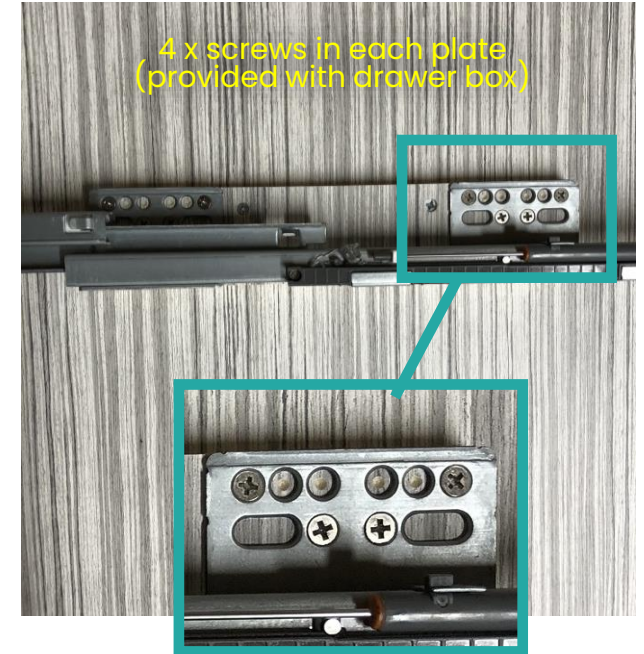

Fit the runners to the blocks using the pilot holes provided, ensure you have the correct runner on each side. Repeat on opposite fridge pod

(CONT.)

FLOOR ASSEMBLY

OVERVIEW

The integrated floor design allows you to build the units in the comfort of a workshop or garage then simply lift them into the van. This allows for any electrical work to be carried out before the units have been fitted. Take care when lifting the units, and never lift from the floor alone as you may snap the join.

(CONT.)

FLOOR ASSEMBLY

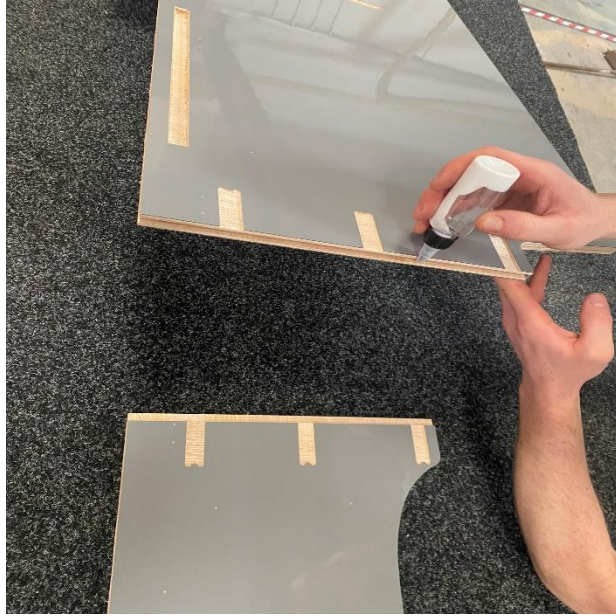

Glue the biscuit joint, do not over glue

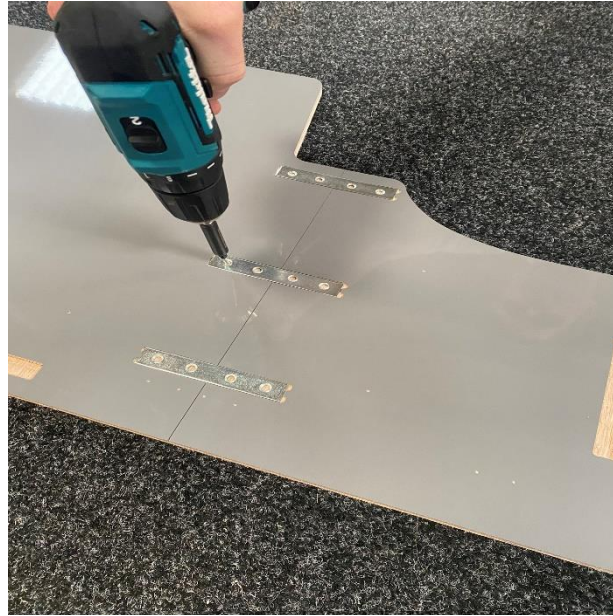

Screw the floor together with the fixing plates using 16mm screws



Now finally Trim the floor as a one

WARDROBE ASSEMBLY



TOOLS

- Drill Driver
- Mallet
- Stanley knife
- Sand paper
- Cross head Screw driver
- Tape Measure
- Set Square

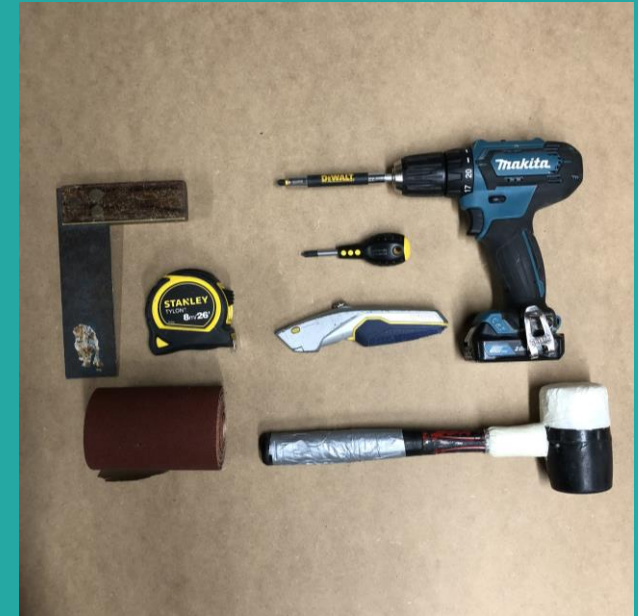

(CONT.)

WARDROBE ASSEMBLY

OVERVIEW

The wardrobe is the most time consuming part of assembly

Its important you follow each step in order of instruction

Use 16mm screws unless directed otherwise

This is a two person job

You will need a large clean flat surface

Do not counter sink 25mm screws

TAMBOUR APERTURE

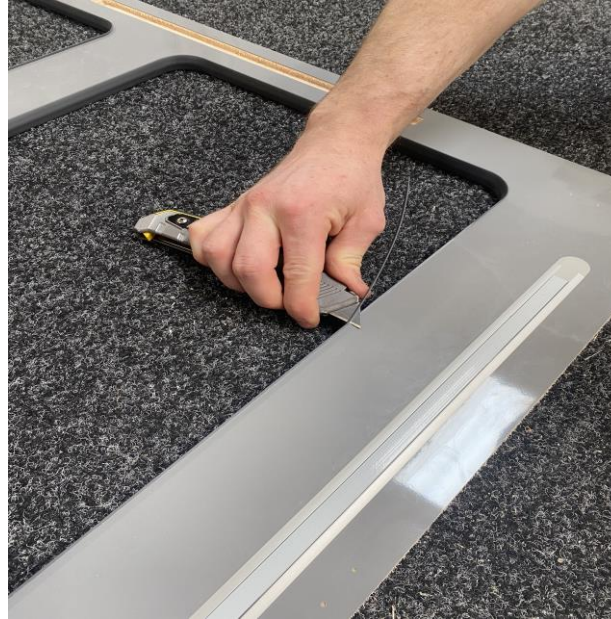

Always remove the rear trim lip from any tambour door aperture, failure to do so will result in a noisy and rough tambour opening, if you have no upgraded tambour ensure to do this on the large standard tambour

(CONT.)

WARDROBE ASSEMBLY



Firstly, stick the wardrobe LED into the profile and re attach the cover case

(CONT.)

WARDROBE ASSEMBLY



Remove the T Trim lip from the underside of the bottom shelf inner

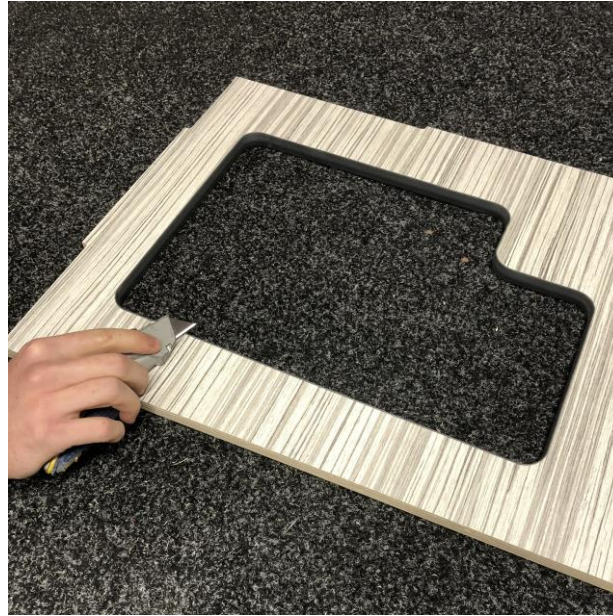

Remove the T Trim lip from the underside of the bottom shelf

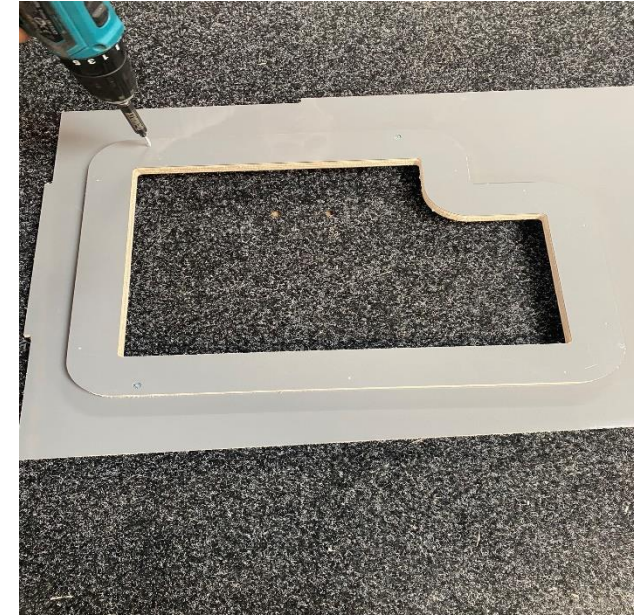

Fix the wardrobe bottom shelf inner to the underside of the shelf using 25mm screws

(CONT.)

WARDROBE ASSEMBLY



Place the wardrobe face down



Slot the bottom shelf, divider
and lid shelf into the rebates
DO NOT SCREW



Fit the wardrobe upright (L)
first, align all rebates and start
from the base working up to
the top using the blocks and
pilot holes

(CONT.)

WARDROBE ASSEMBLY



Fit the wardrobe upright (R) align all rebates and start from the base working up to the top using chock blocks and pilot holes



Ensure all rebates are flush and fit together nicely

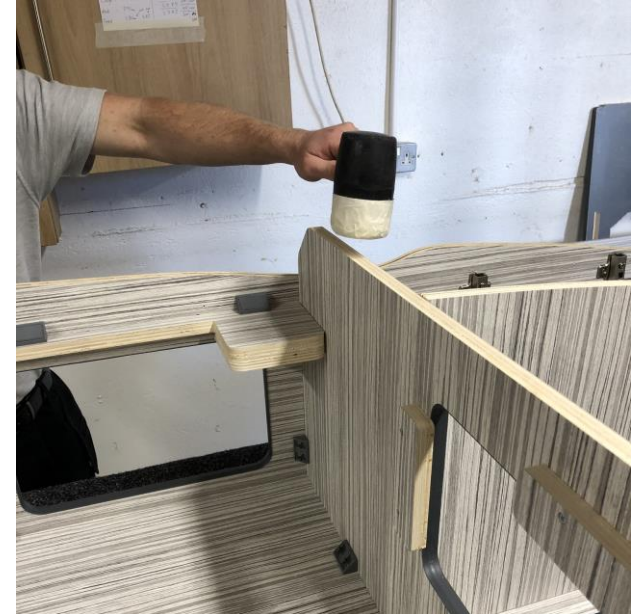

Ensure the bottom shelf is seated correctly before fixing

(CONT.)

WARDROBE ASSEMBLY

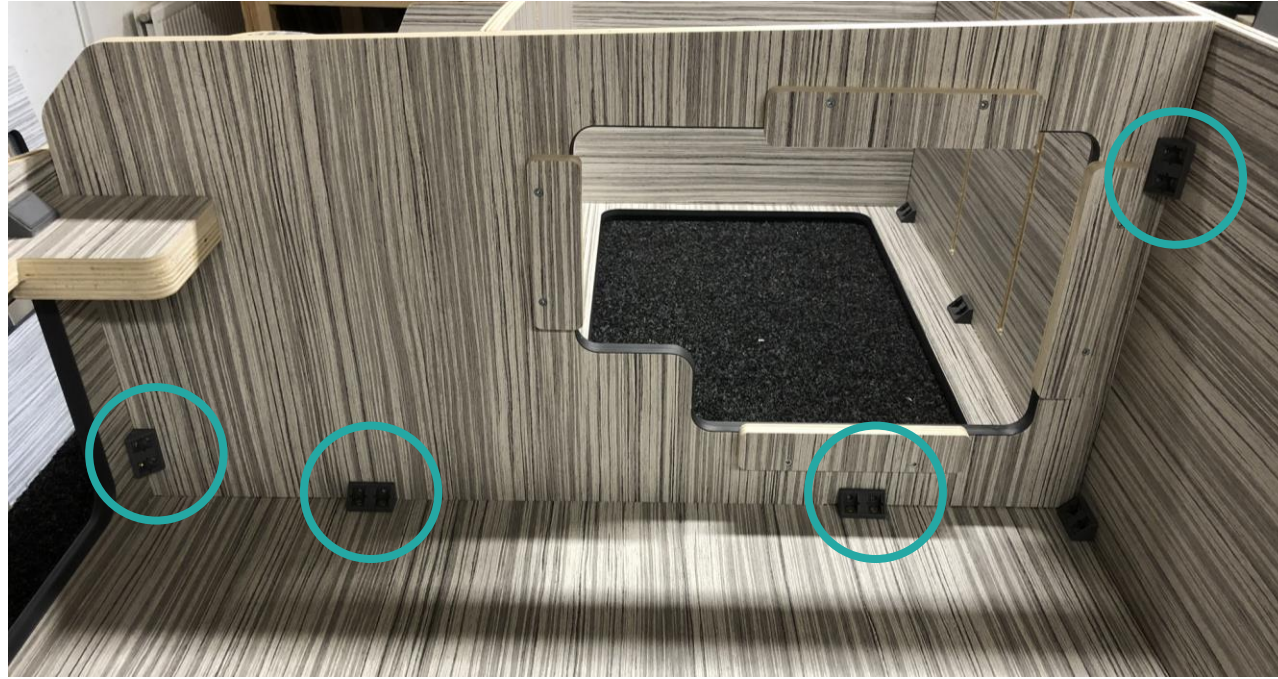

Screw the bottom shelf together using the blocks and pilot holes provided, ensure the joins are tight and flush

(CONT.)

WARDROBE ASSEMBLY

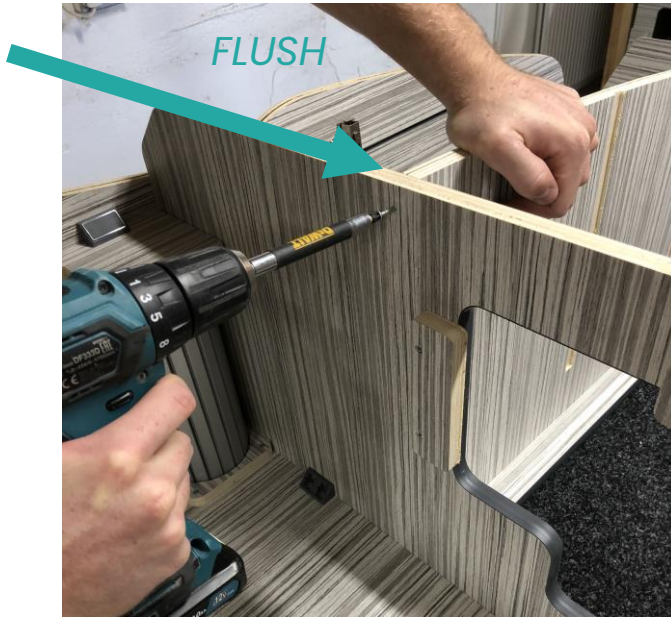

Screw through the bottom shelf into the divider using a 25mm screw*



Fit the lid shelf to the upright (R) ensure the joints are tight and flush



Secure top of divider with a block

*You may countersink

(CONT.)

WARDROBE ASSEMBLY



Repeat the process with
the left upright



Now screw the lid shelf to the face.
Please note, your blocks may be
underneath the lid shelf

(CONT.)

At this stage you have two choices, you can continue to assemble outside the van or begin to build inside. Building outside the van is easier, however requires an awkward three-man lift of the fully built units when finished. If you do not have three strong people available to lift, we recommend placing the floor base in the centre of the van and continuing inside



(CONT.)

WARDROBE ASSEMBLY



Stand the wardrobe up click into the floor rebates.



Fix the wardrobe to the floor using 16mm screws, and pilot holes provided



Continue

(CONT.)

WARDROBE ASSEMBLY



Screw the large tambour door wheel (R) to the bottom shelf using 25mm screws



Repeat the process with the opposite wheel on the lid shelf



Insert the tambour door into the wheel runners from the rear

(CONT.)

WARDROBE ASSEMBLY



Glue the bottom track 14b onto the bottom shelf butt up to the tambour wheel. Repeat the process for the top track



Close tambour door, Slide the Wardrobe tambour door upper shelf into rebates, then fit using chock blocks underneath with the pilot holes provided



(CONT.)

WARDROBE ASSEMBLY



Repeat the process for the Wardrobe tambour door lower shelf



Fit the blocks for the Wardrobe rear shelf

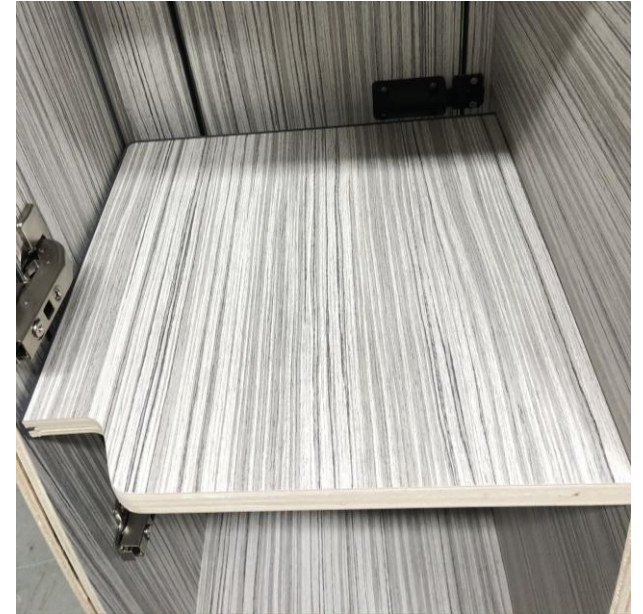

Fit the Wardrobe rear shelf flush with the rear

(CONT.)

WARDROBE ASSEMBLY



T Trim the Wardrobe upright (L) starting on the arrow. Trim lip outside



T Trim the Wardrobe face starting on the arrow. Trim lip outside

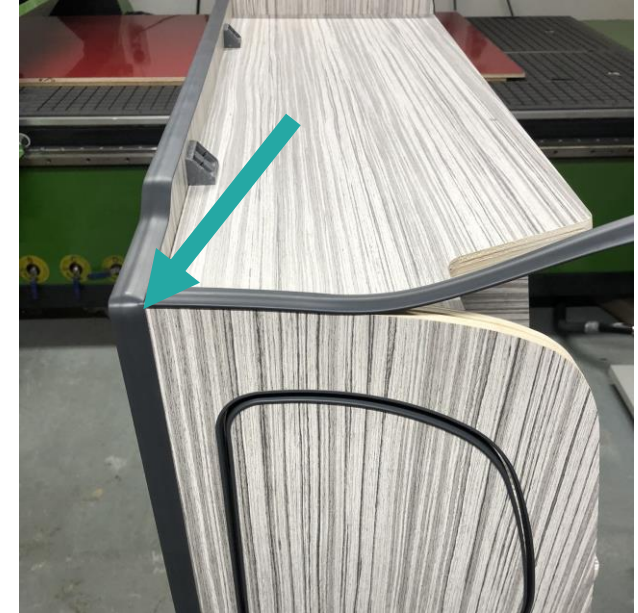

T Trim the Wardrobe upright (R) starting on the arrow. Trim lip outside

(CONT.)

WARDROBE ASSEMBLY



Finally slide the cubby
hole insert into place

ASSEMBLY



Fit the Kitchen unit face
from the rear



Ensure the face is flush
with the wardrobe



Fit the shelf blocks

ASSEMBLY



Fit fridge pod (R) from behind, if you have the new twin door design fit with 1 x block at the top using the pilot holes



Fit the Kitchen unit shelf

ASSEMBLY



Fit blocks to the flap divider and fit to shelf using the rebate

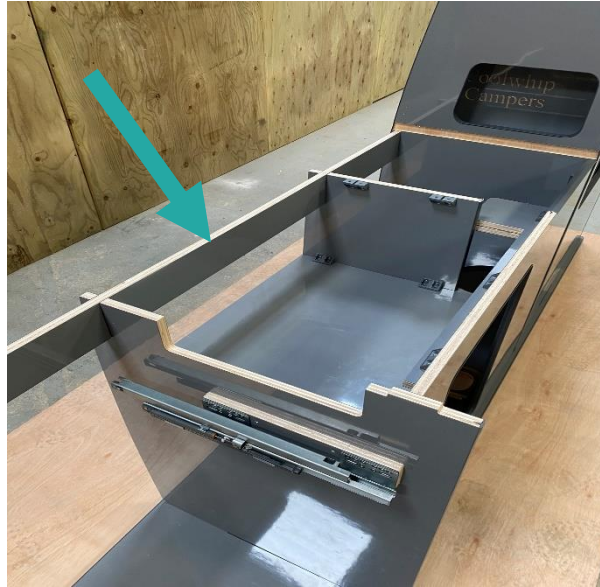

Now fit the rear support into place, be sure to have it the correct way



Now fit the fridge pod upright (L) and click rear support into place

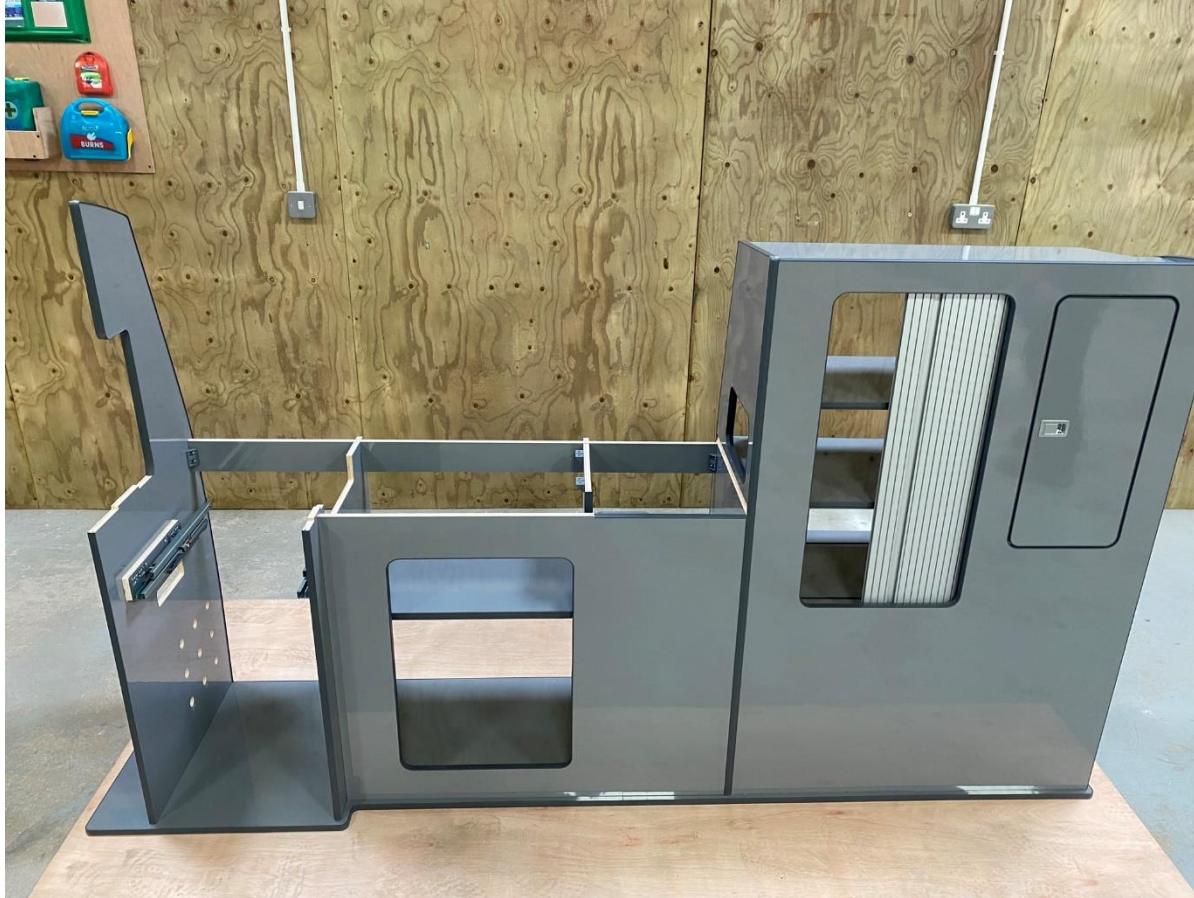

ASSEMBLY



Mark and cut away the overhanging Trim on the inside of the drawer upper support

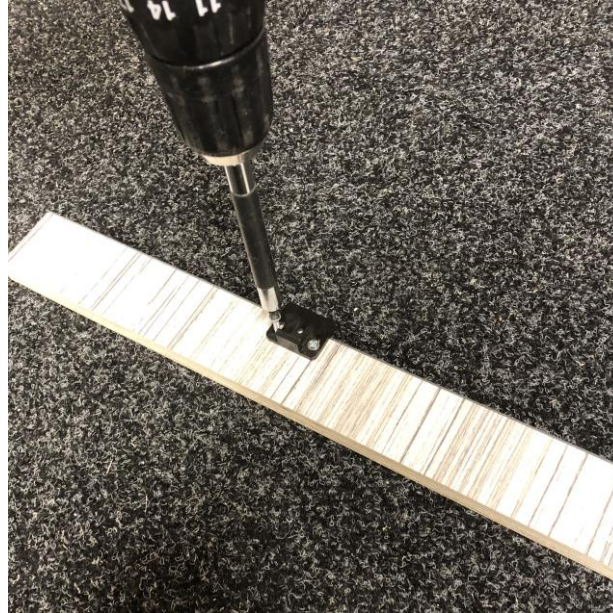

Screw the strike plate with 16mm screws



Fit the two chock blocks to the drawer upper support

ASSEMBLY

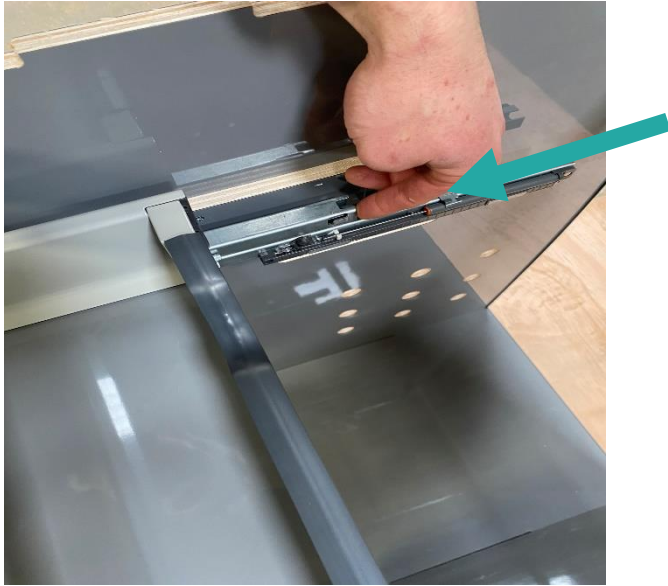

Fit the drawer to the runners, there is an audio click when the runners are pushed in correctly

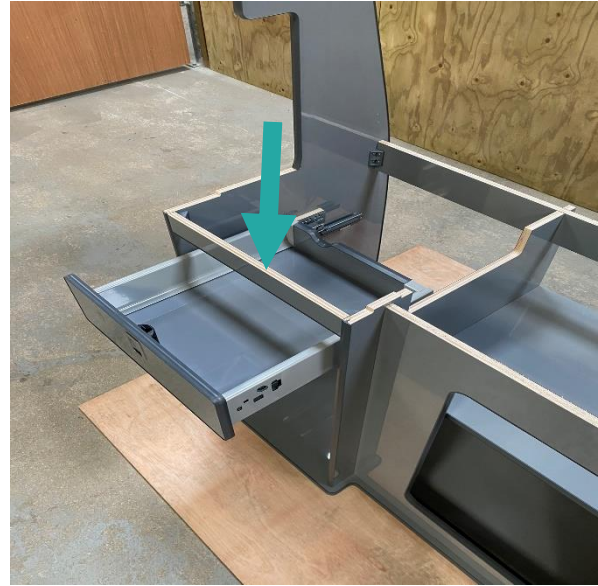

Now you can fit the drawer upper support above the drawer

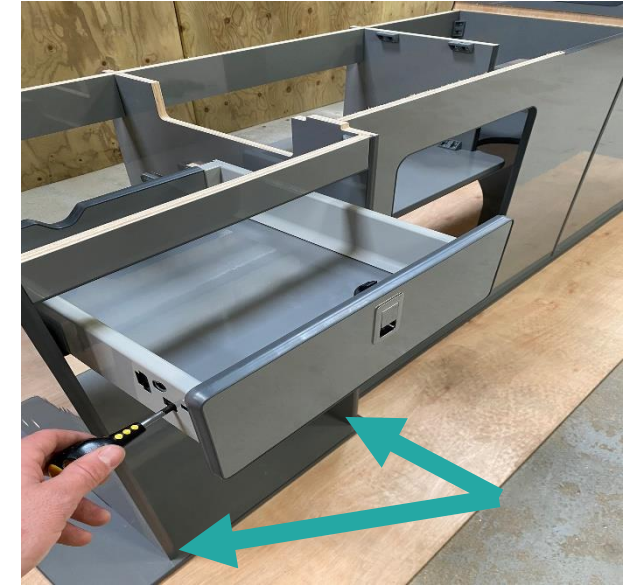

Adjust the drawer to fit perfect, ensure both fridge pods are equally 15mm from the base front

Please see drawer box manual for more information on how to align the drawer, remove from runners and any other information you may require.

ASSEMBLY

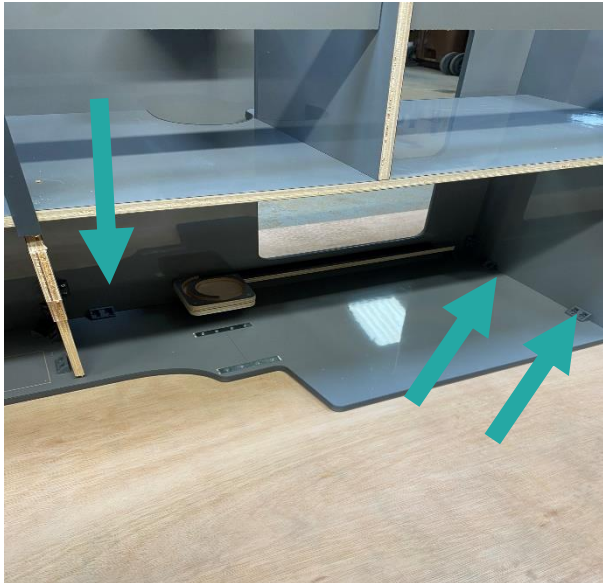

Continue to screw the units to the floor, ensuring the face is inline with the cupboard 15mm from the floor edge



Fit the fridge upright (L) to the floor using 2 x small L brackets on the inside of the aperture, do not use blocks as they obstruct with the fridge



Fit the right side table storage holder to the outside front of your fridge pod (L) with 16mm screws

FITTING THE TABLE LEG AND RAIL



(CONT.)

REAL OAK

STOP!

Before screwing through any real oak please ensure you pilot drill first, failure to do this may result in The oak splitting

FITTING THE TABLE LEG AND RAIL



Screw the table leg into the underside of the table with 4 x 20mm screws provided, ensure central



Fit the rail brackets 40mm from the table edge with 4 x 16mm screws in each bracket



Align the rail central and 30mm from the unit top

FITTING THE TABLE LEG AND RAIL

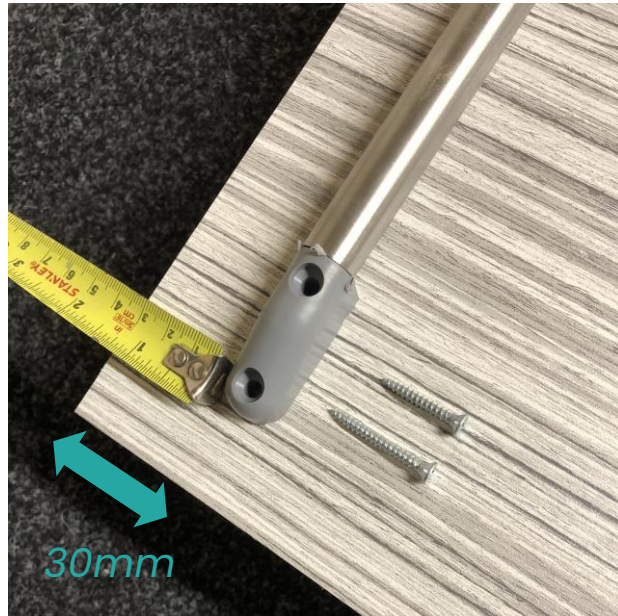

Rail 30mm from top of unit face

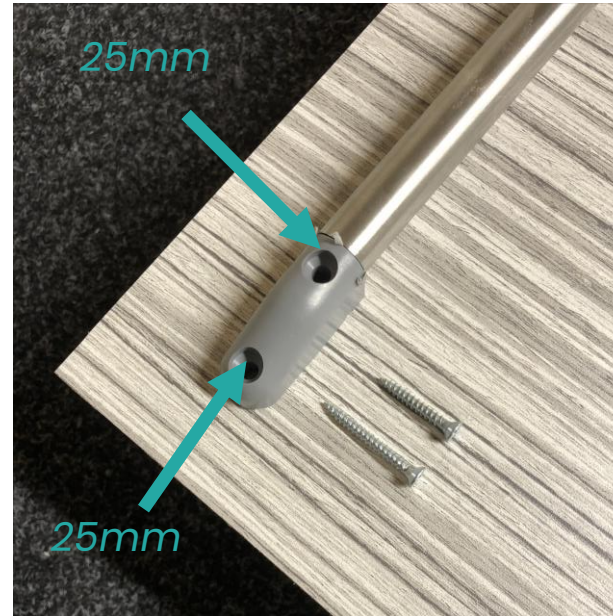

Fit the rail using a 25mm screws

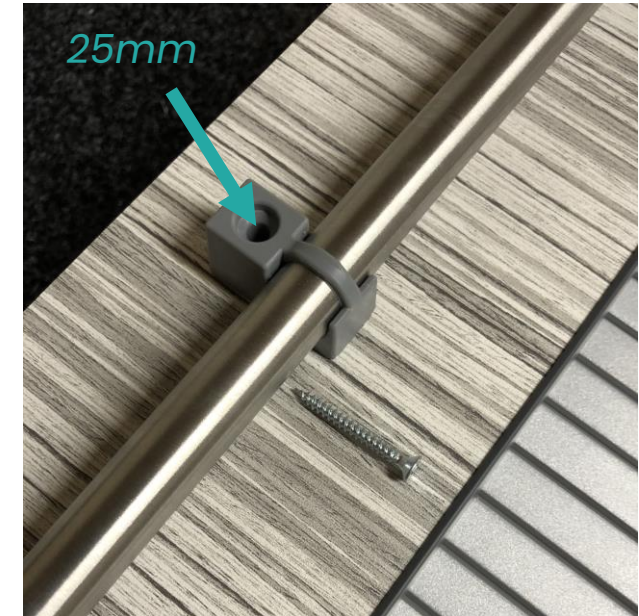

Fit the center support using a 25mm screw

TABLE STOWAGE



Offer the table in and fit the left side storage holder, ensure its not too tight



Now fit the stowage clips using 30mm screws, the front one alone is sufficient, you will also find it easier removing the table when fitted

WORK TOP



Using the alignment rebates, drop the worktop into place. Start by offering the right of the worktop into the wardrobe rebate, then simply find the rebates at seat correctly. Do not forget to fix down with blocks and 16mm screws, we advise pilot hole drilling the rear oak first

ASSEMBLY



Cut the trim to fit flush with the worktop surface



Fit the drawer cover caps and insert your chopping board

TOP LOCKER ASSEMBLY



Before fitting the top locker and splashback, if you have a low fitting pop top such as the 'High-low roof' this is a good time to dry fit your units, because you may need to trim the top of the left fridge pod to fit. The way the units are designed allows you to trim accordingly, thus allowing you to position the locker in a lower position. Please note, pilot holes both sides will then be obsolete

TOP LOCKER ASSEMBLY



TOP LOCKER ASSEMBLY



If you have not done so already, fully prep your top locker for installation, do not forget to stick the LED in the profile poking the Qijie clip through the hole

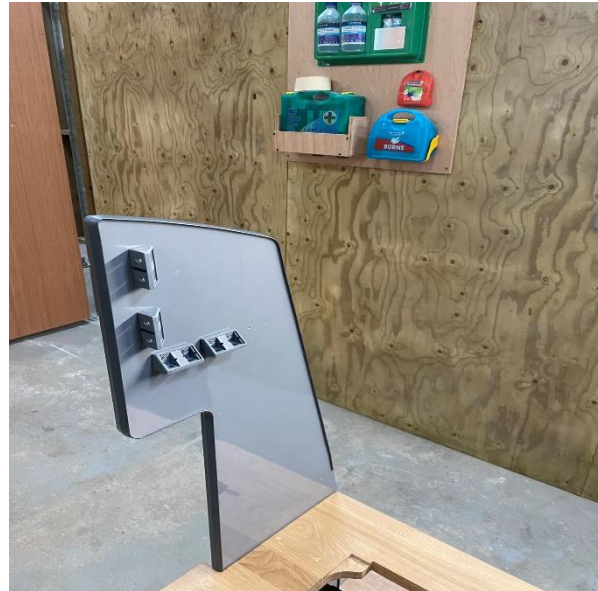

Screw the blocks in place ready



With two people, offer the locker up and screw into place

ASSEMBLY



Now neatly finish the trim around the top locker to butt nicely into the wardrobe upright (L)



Remove rear of trim from fridge pod (L) and wardrobe upright (R) ready for the splash back



Offer the splash back up, allow it to sit on the worktop surface and lean into the base of the top locker

ASSEMBLY



Fit the splash back with 3 x
small L brackets on the rear
with 16mm screws

TOP LOCKER ASSEMBLY



Measure from the worktop surface to the underside of the top locker to ensure its parallel before the next step

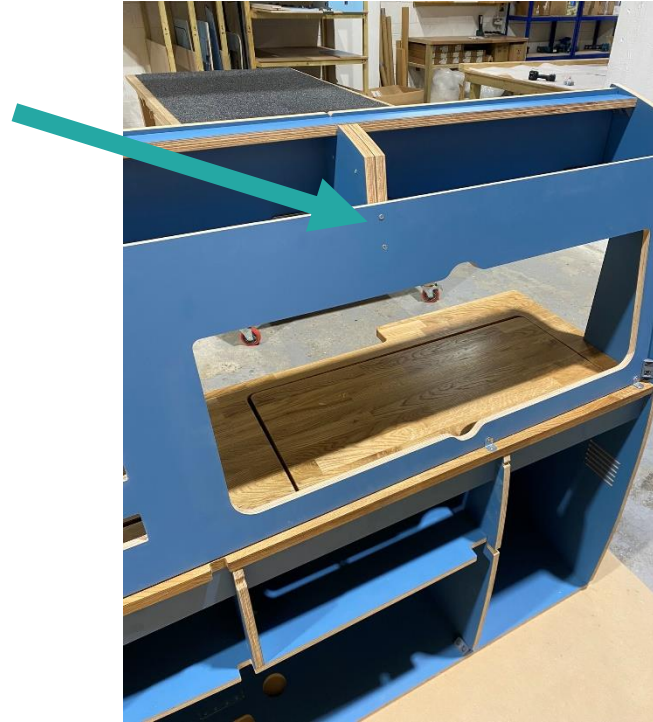

Screw through the splashback into the divider



For further strength, screw through the splashback into the top locker base, ensure you are screwing in the correct place by measuring (pilot drill first)

If you have purchased furniture only skip to slide 115 for fitting





COOLWHIP
CAMPER CONVERSIONS

*ELECTRIC PACKAGE
INSTALLATION INSTRUCTIONS*

STOP & READ

Please ensure you briefly read over this instruction manual before attempting to fit the electrical components and looms to your units. Once you have an understanding of the process and feel confident carrying out the install, please read and follow each page step by step, failure to do this can result in mistakes and the process taking much longer.

Our integrated floor design allows you to build the units in the comfort of a workshop or garage then simply lift them into the van. This allows for any electrical work to be carried out before the units have been fitted. Take care when lifting the units, and never lift from the floor alone as you may snap the join. We recommend not trying to build in the van, you will require a good amount of space and a workbench



CONTENTS

73-75	Electrical diagrams
76-80	Sink/ grill combo
81-92	Electrical component installation
93-97	Van earth point
98-100	Unit installation
101-103	Leisure battery
104-114	Split charge & 240 hook up connection
115-118	Securing the units

THE PROCESS

Read instructions,
prepare workspace
and tools



Sink/ grill
combo



Fit earth cables to
van earth point



Fit electrical
components
and loom



Lift unit into
the van



Connect to
Leisure battery



Connect to
Vehicle battery &
240 hook



Secure the
units



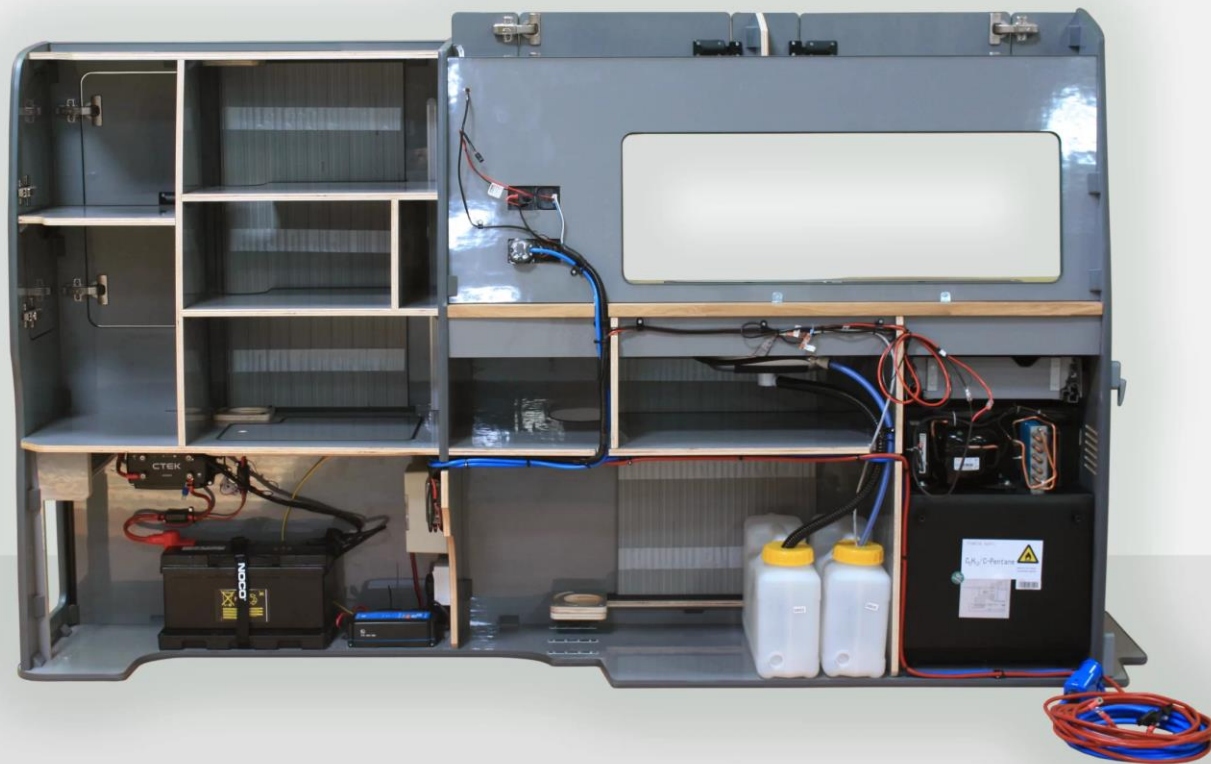

DISCLAIMER

Please note, this instruction manual is a guide to how we recommend the following stages are carried out. Although the looms and components are prewired and labelled, you will require a basic understanding of electrics. If you are not confident in this process, we recommend seeking advice or help from a professional.

All components and looms are pre-tested on our mock up kit to pass quality control before leaving us, any issue that arises will be a result of incorrect assembly and will require a fault-finding process. For example, the entire electrical loom may not be live due to one simple loose connection. Please ensure you have followed the steps correctly.

Although we may be able to advise, we are a product-based company, all components are brand new and tested. If you are still unable to diagnose where any electrical issues are, we recommend seeking advice or help from a professional.



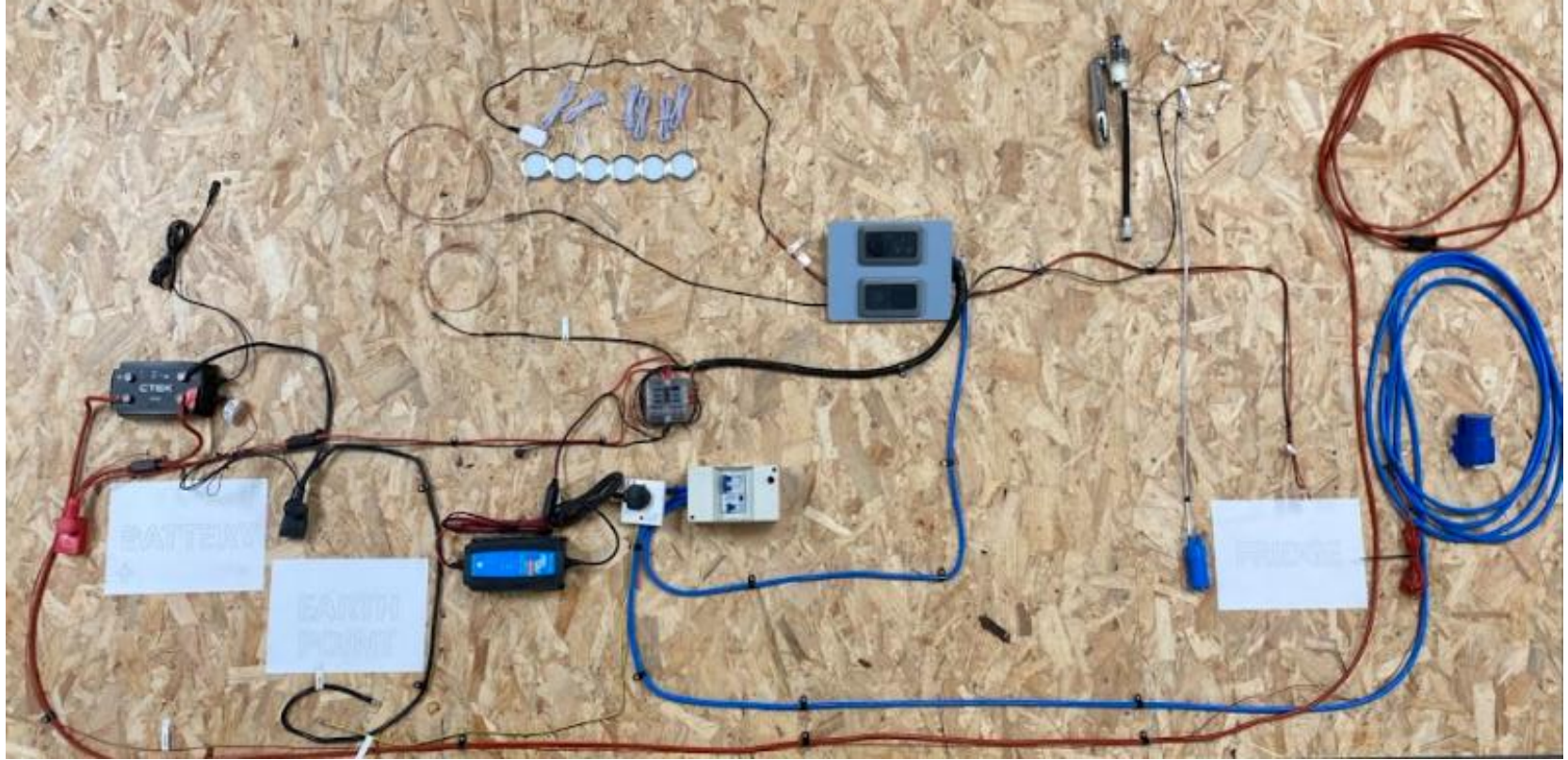

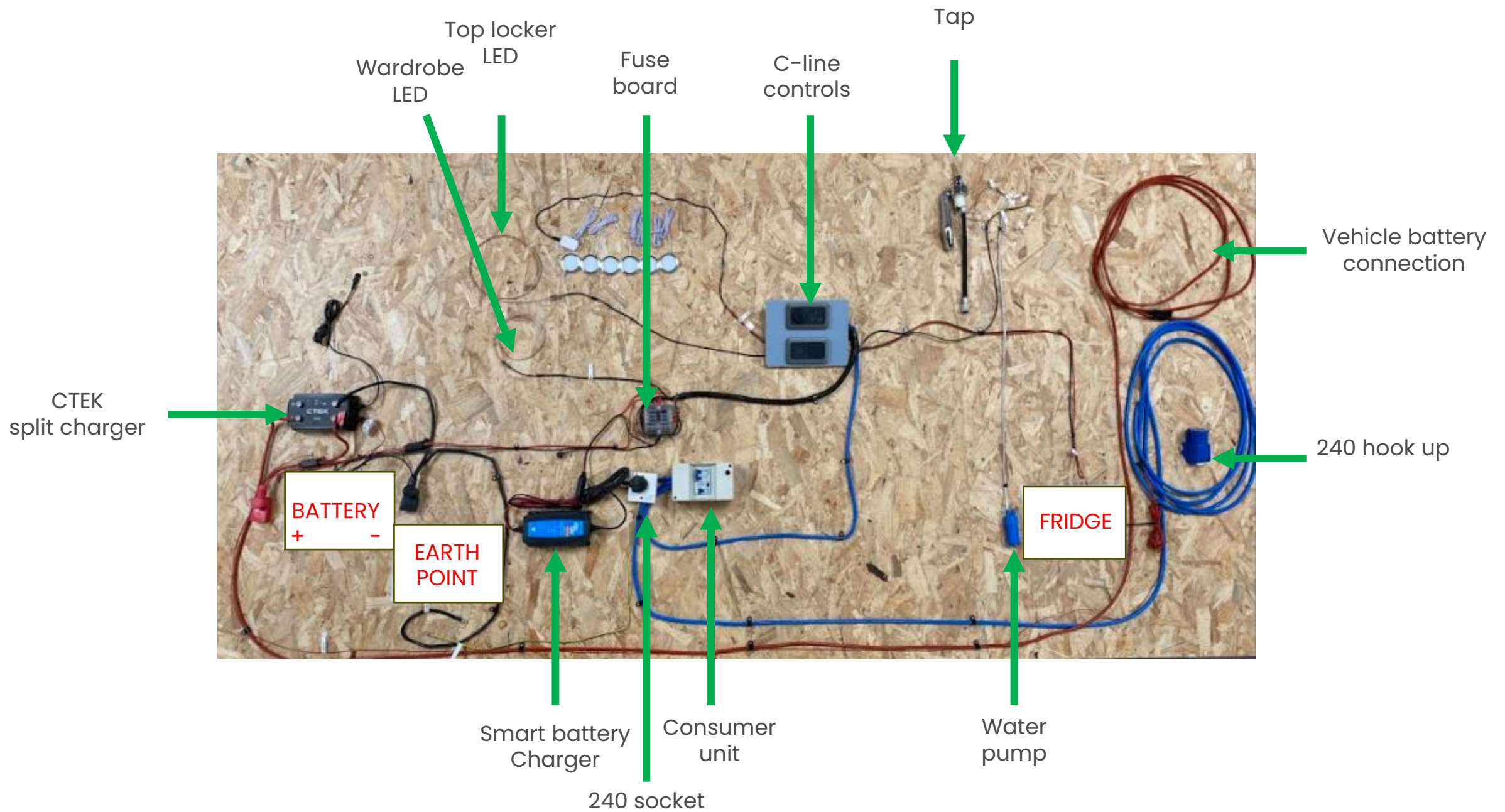

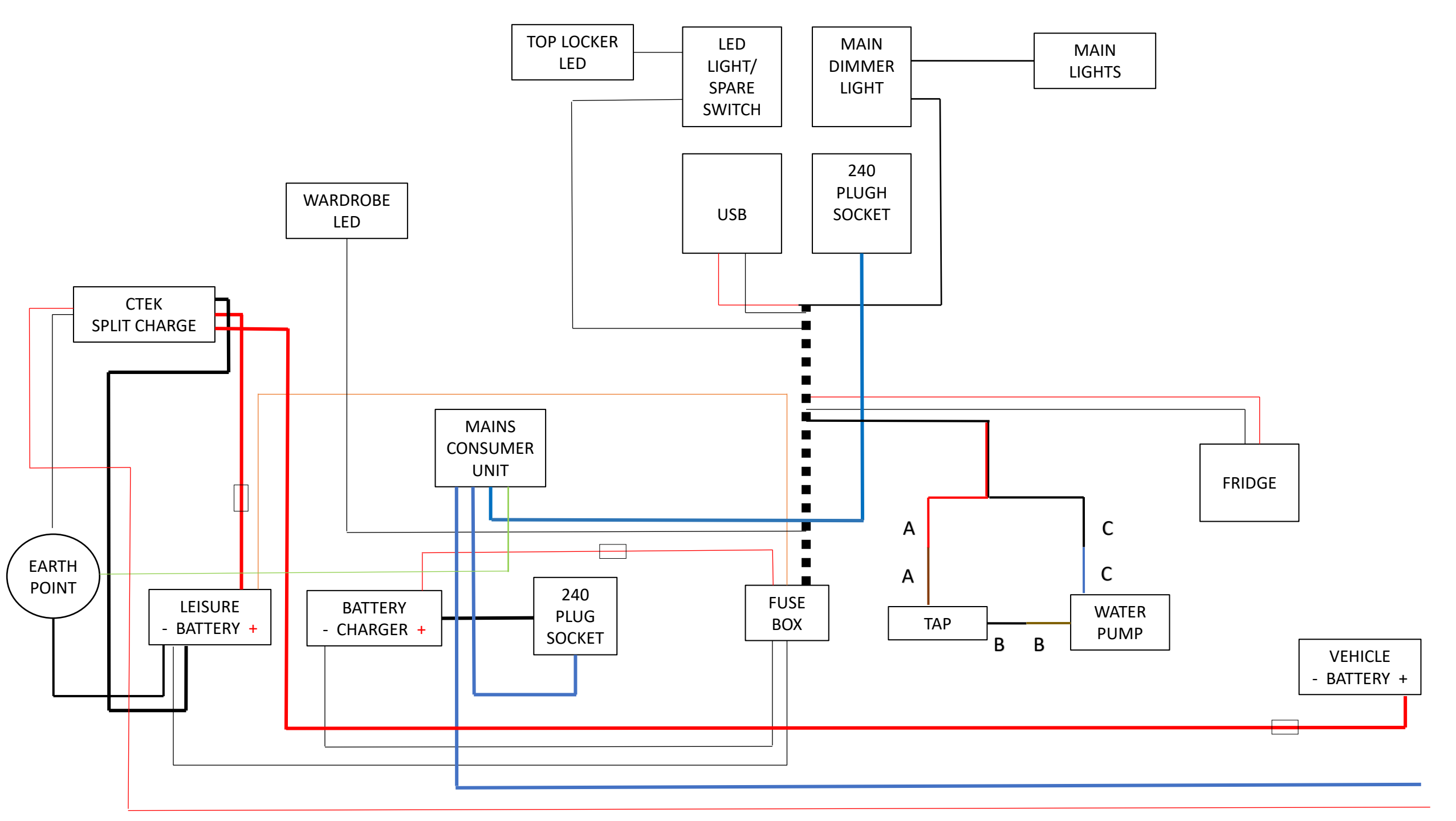

SINK/ GRILL COMBO



Remove the protective masking tape



Fit the rubber edging, cut on completion and butt together

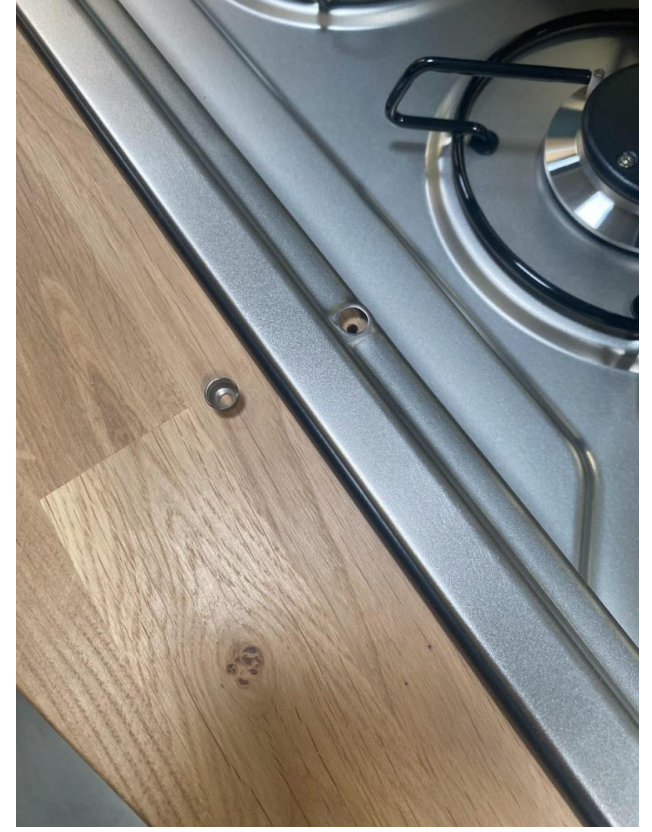

Fit the screw inserts, pre-drill any oak material

SINK/ GRILL COMBO



Screw into the worktop using the screws provided with the appliance



Fit the black screw caps

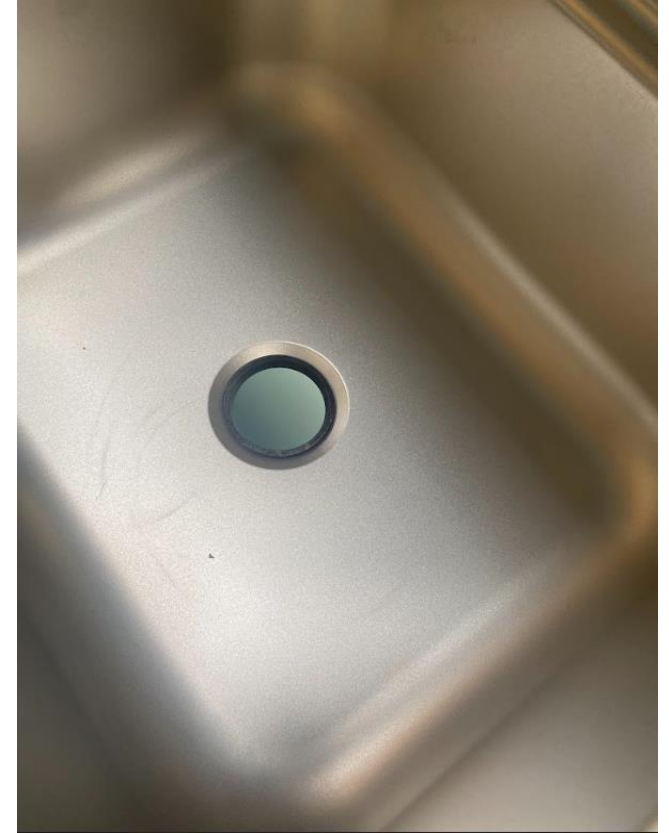

Fit the plug rubber seal

SINK/ GRILL COMBO



Screw the drain into place

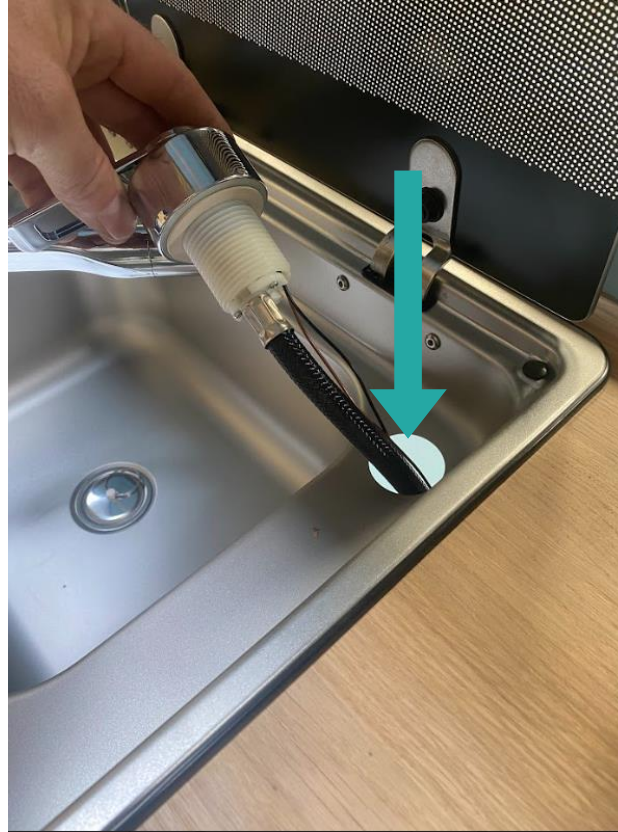

Feed the tap through the tap hole



Feed the rubber seal then fixing thread over the water pipe and cables from behind and tighten

SINK/ GRILL COMBO



Heat one end of the freshwater pipe in hot water



Manipulate the pipe to give a wider berth

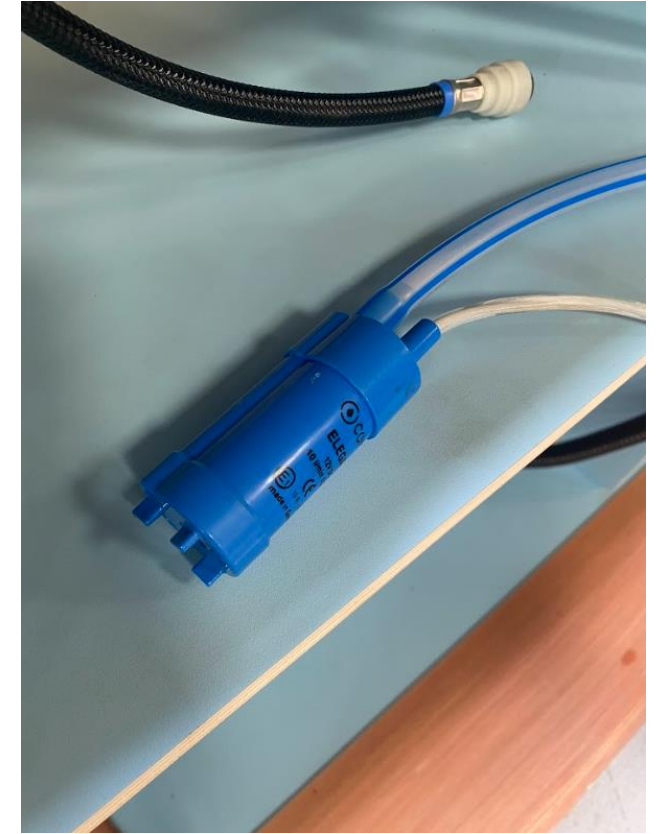

Fit the pipe to the water pump

SINK/ GRILL COMBO



Fit the other end to the tap inlet, push firmly, there will be an obvious audio clip



Fit the 20mm waste pipe to the grey outlet under the sink, fasten with jubilee clip, heating in water may be required

STOP & READ

Always use 16mm screws unless stated otherwise, failure to do so will result in screwing the furniture board

FUSE BOARD AND MAIN LOOM



Screw the fuse board into place using the pilot holes provided

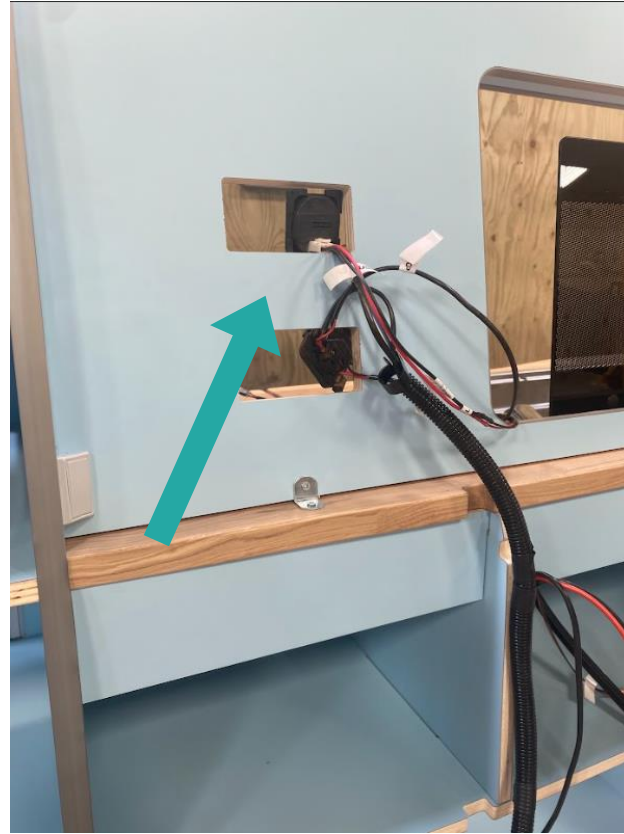

Feed the control switches through the C-line cut outs



Using the cut outs in the furniture, run the fridge and tap cables into place and p clip into position

TAP WIRING DIAGRAM

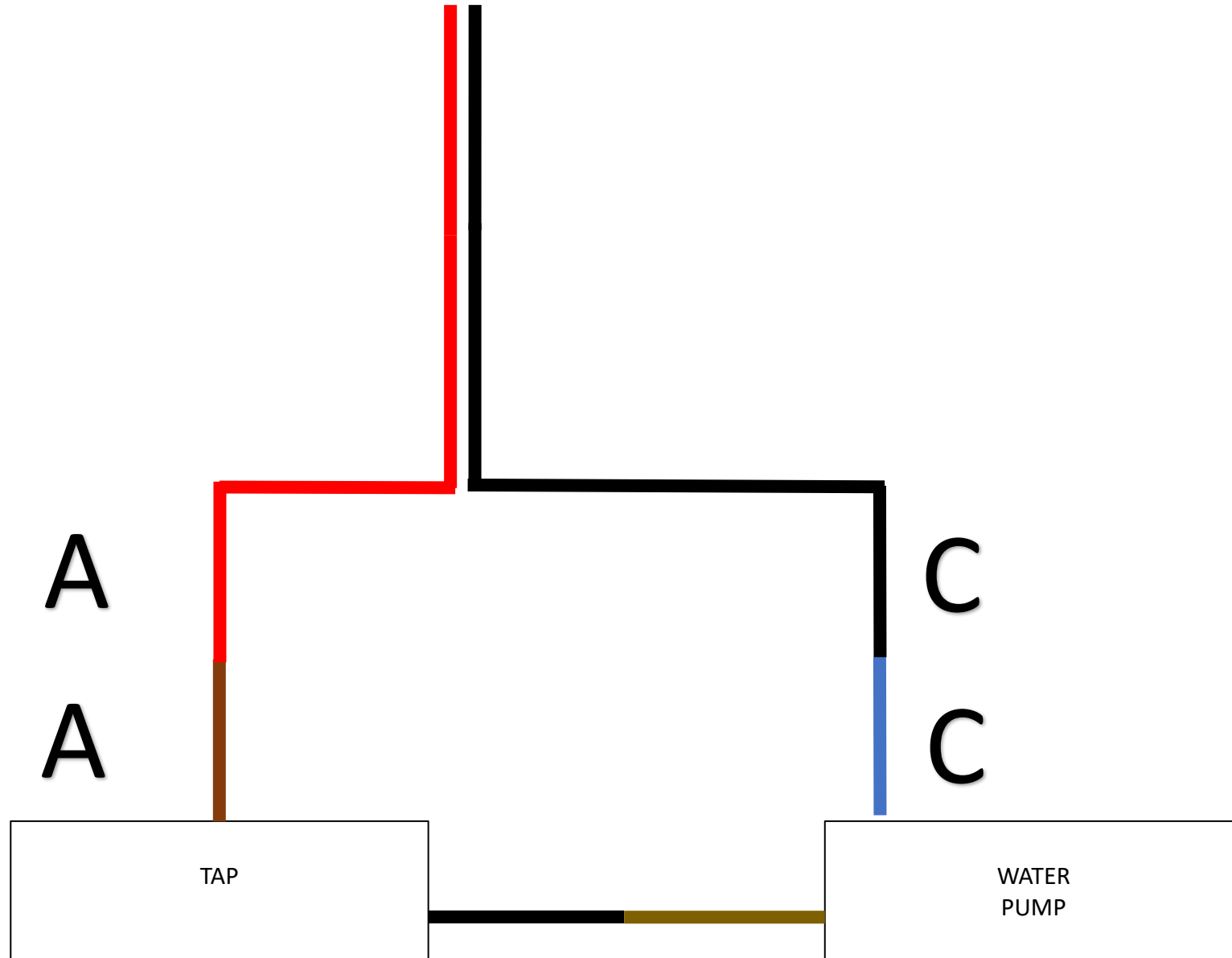

TAP

Feed the cable and fresh pipe through hole on the water tank lid before installation

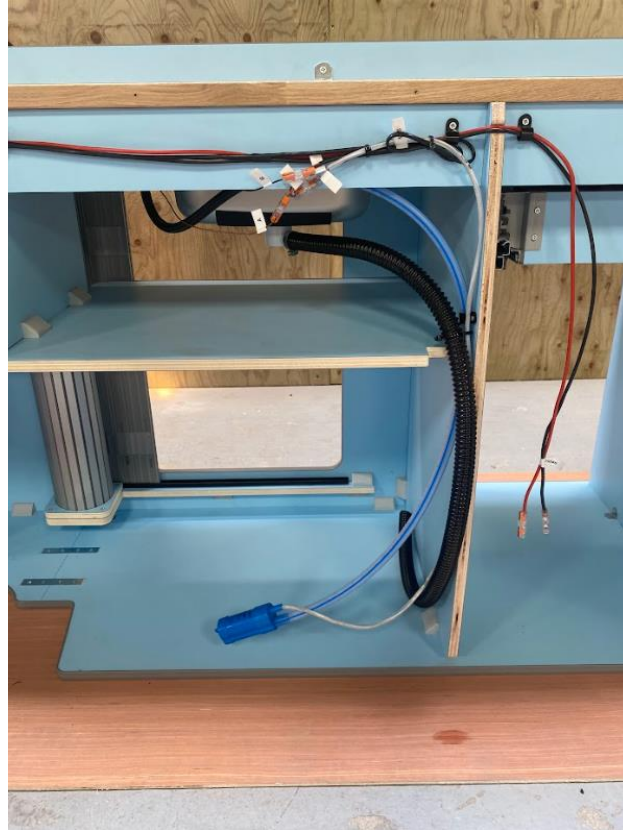
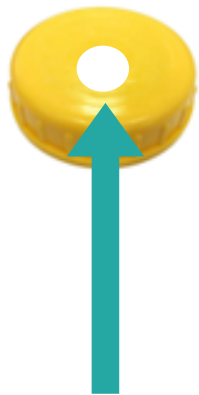

Connect the tap and water pump using the labelled wago connectors, then P-clip or cable tie away



P-clip and cable tie the waste, water pipe and tap cable into the shelf notch

CONSUMER UNIT & SOCKET



Remove the consumer unit face and fit into position, ensure the short single 3 core blue cable and earth exits the bottom



Remove the 240 socket face and fit on the square below



Finally refit both faces

C-LINE CONTROL PANEL



Remove the back cover of the 240 C-line socket

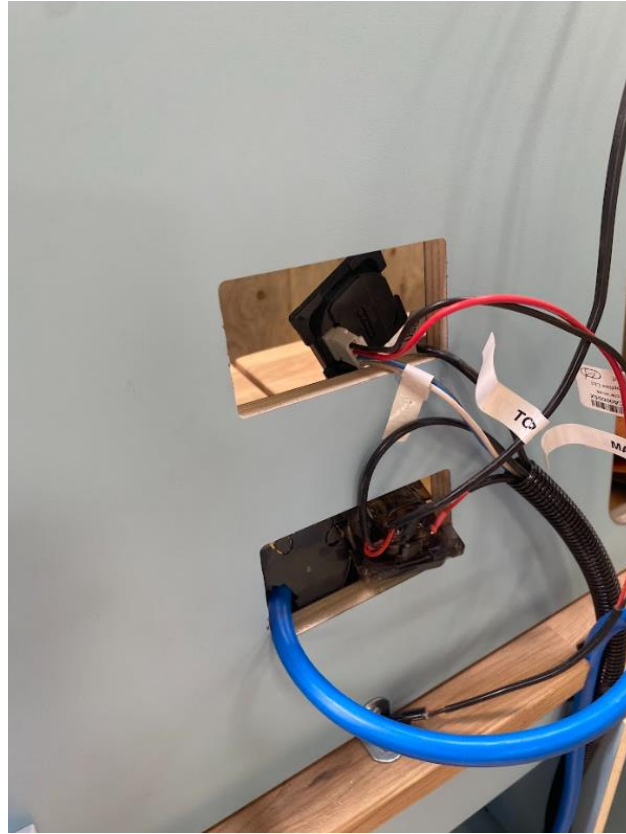

Now feed all controls through the C-line cut outs



Re attach the back cover of the 240 C-line socket

C-LINE CONTROL PANEL



Clip the controls into the fixing plate then screw into place aligning with the pilot holes provided



Clip the finishing cover plates over the top into position

CTEK/ BATTERY CHARGER AND TRAY



Screw the CTEK split charge into position, you will require 25mm screws



Screw the smart charger into position and connect



Before fitting the battery tray remember to feed the strap underneath

BATTERY TRAY



Fit the battery tray using the pilot holes provided, have the cut-out entry point over the positive side

WARDROBE LED



Clip the Wardrobe LED into the Qijie joiner, ensure the fit is correct

P-CLIP CABLE TIDY

Tidy up all wires and P-clip into place, it's important to have tidy and organised cables, here are a few pictures of how we do it.
Where possible clip AC, DC and water separate

P-CLIP CABLE TIDY



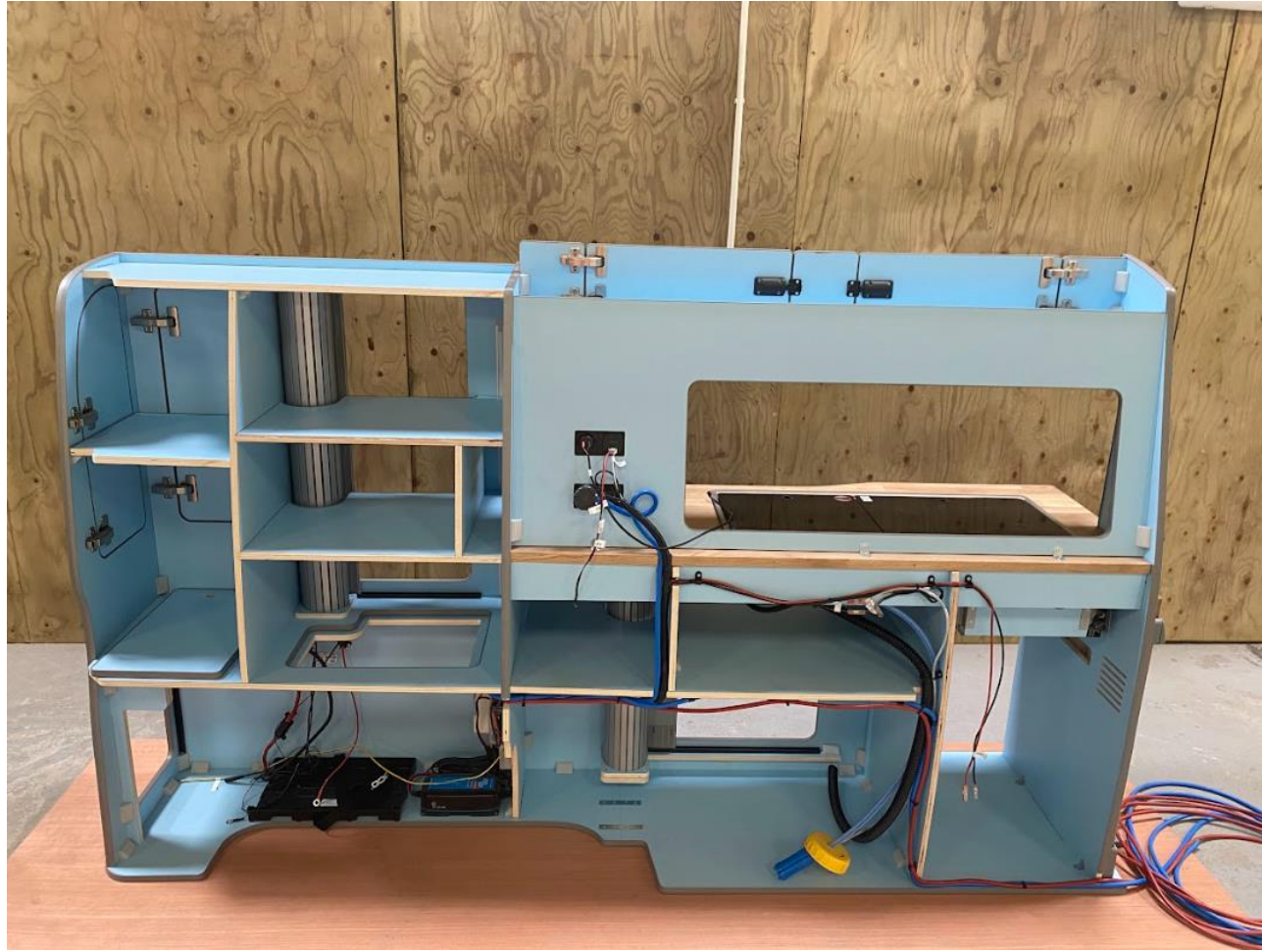

VAN EARTH POINT

In order to access the vehicle earth point, you will need remove and cut a hole in the OS (driver side) rear quarter panel. In the following slides we will show you exactly where and how to do this.

If you are unable to remove the panel, skip to slide 29, we have measured exactly where the earth point is for you to access without removing the panel.

VAN EARTH POINT

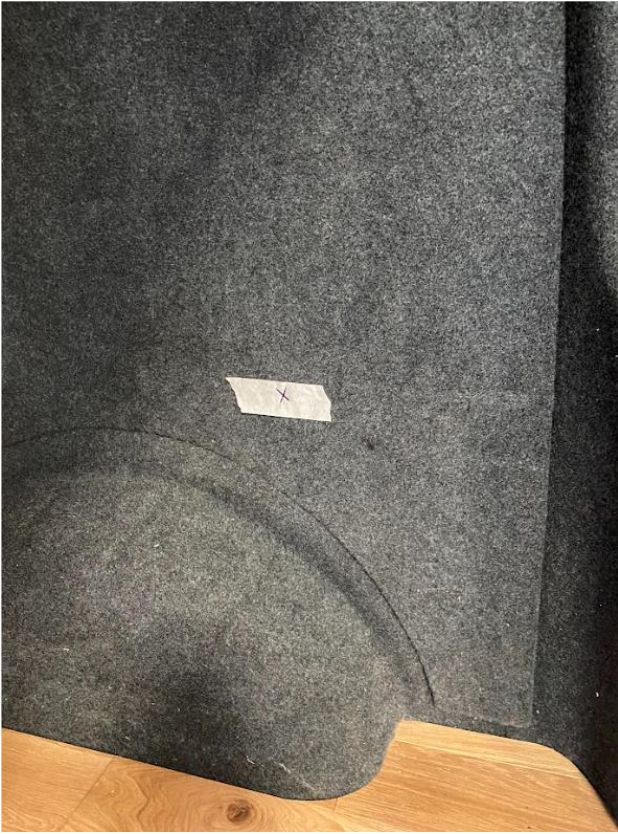

Mark the earth point 330mm from the rear of the panel and 450mm from the van floor

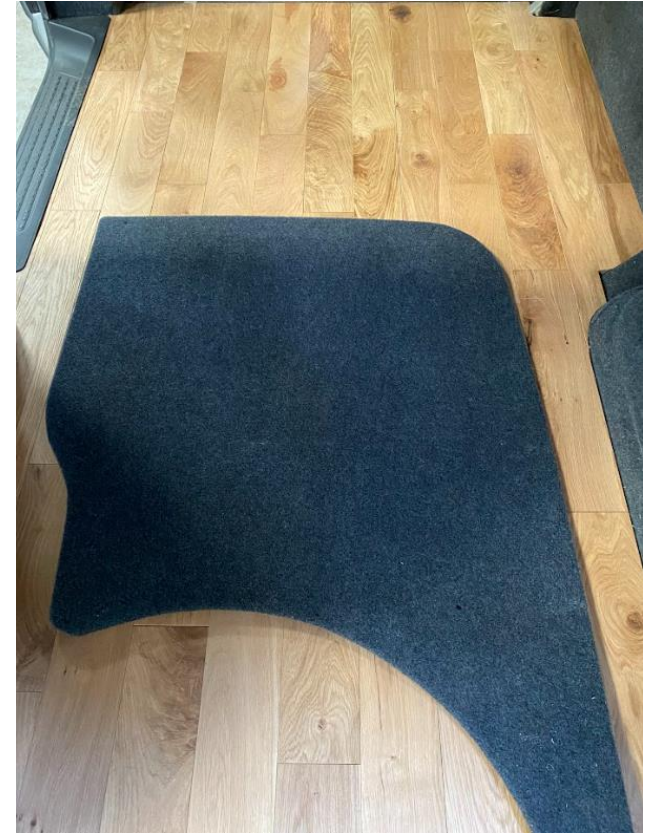

Remove the panel

VAN EARTH POINT



VAN EARTH POINT LOCATION



100mm from the rear panel position



500mm from the van floor

VAN EARTH POINT



Fit the earth cables



Re attach the OS rear quarter panel

INSTALL PREP



Lay some protection to the van floor to prevent any scratches



Tape the 240 hook up and vehicle battery cable inside the fridge aperture

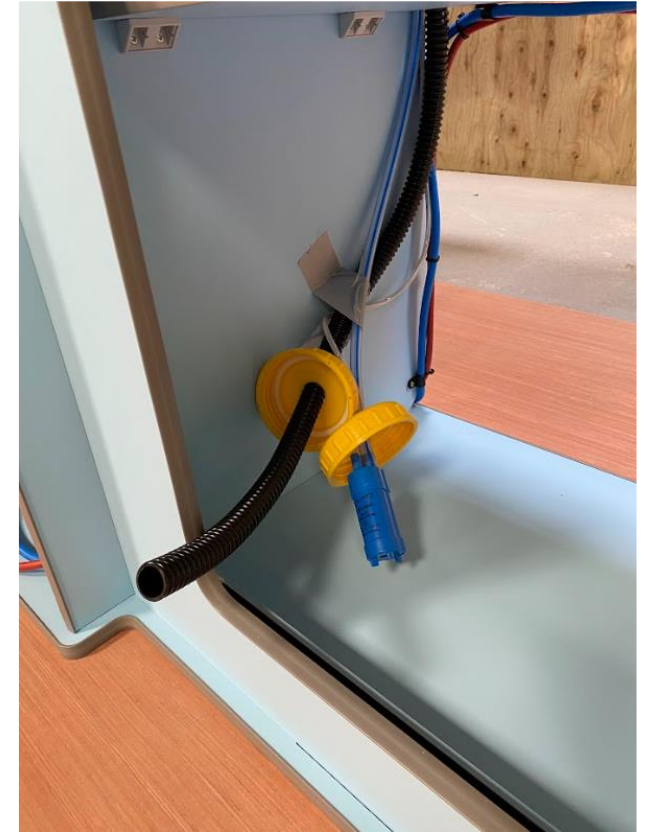

Repeat the process with the water tank pipes

INSTALL PREP



Feed the top locker LED through the splashback hole and connect to the Qijie joiner, ensure the fit is correct



Align the units square and close to the van



Do not attempt to lift with the fridge or leisure battery installed, the units will be too heavy

- Lift the units straight up and place just inside the rear of the van
- Allow the front person to now enter the van and regrip
- Tilt the units anti clockwise from the rear perspective
- Whilst on tilt, lift the units into the centre of the van until you can un tilt
- Ensure the rear piece sits underneath the boot lip
- Do not push back and fit



It's important to note this is a three-person minimum lift.

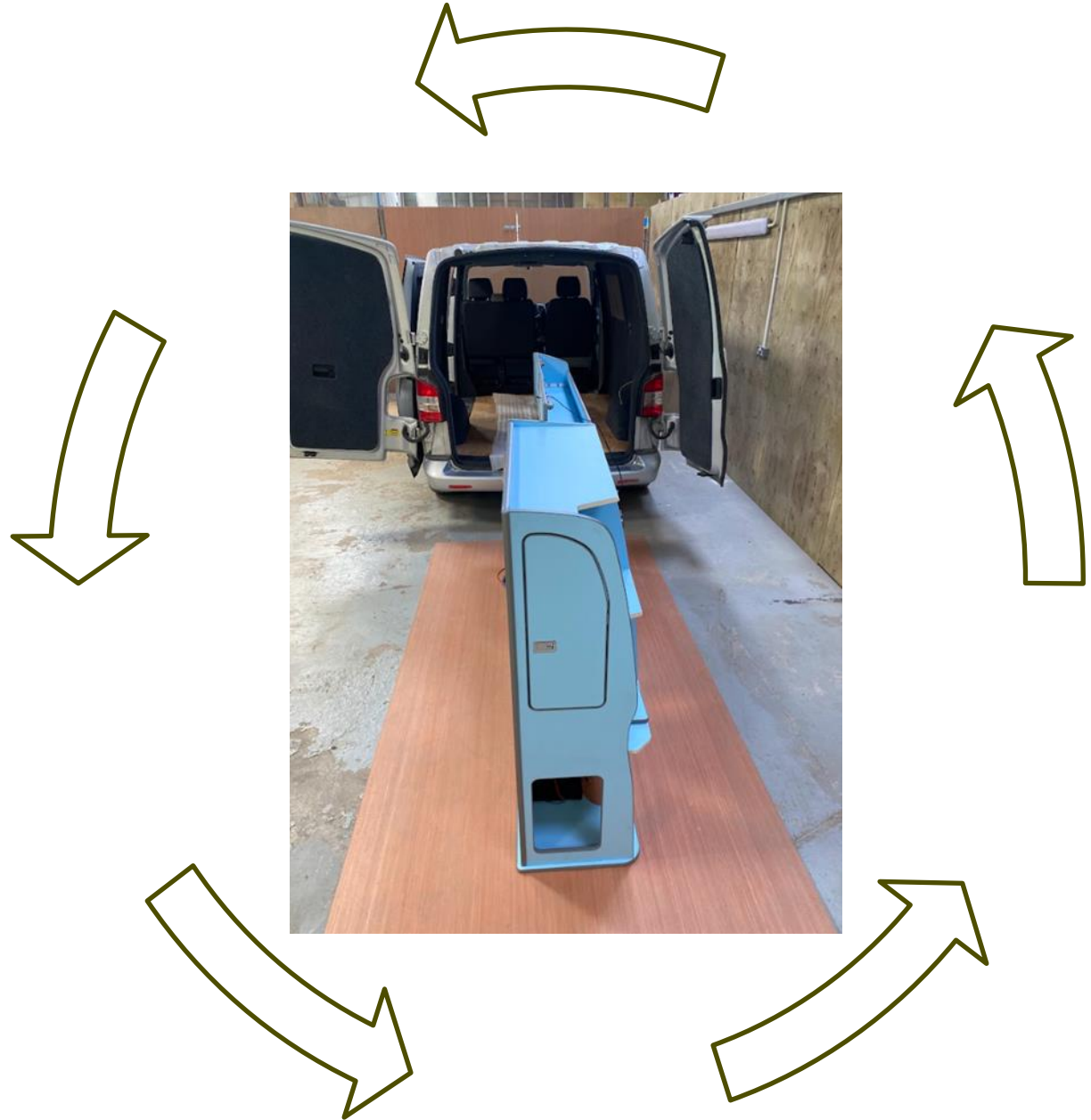

CONNECTING THE LEISURE BATTERY



Attach the battery terminals



Fit the battery to the stary and
secure with the strap

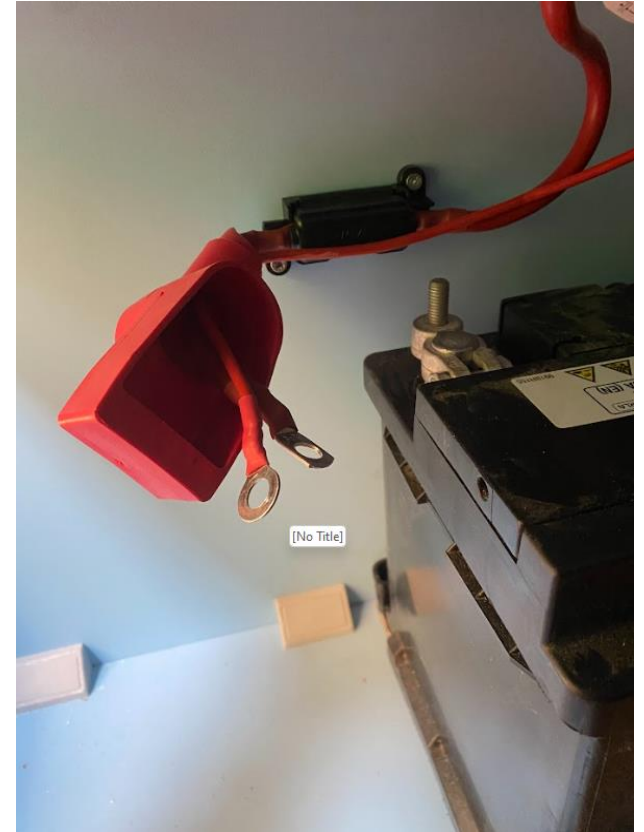

Pull all live red cables and the
CTEK thermometer through
the rubber terminal

CONNECTING THE LEISURE BATTERY

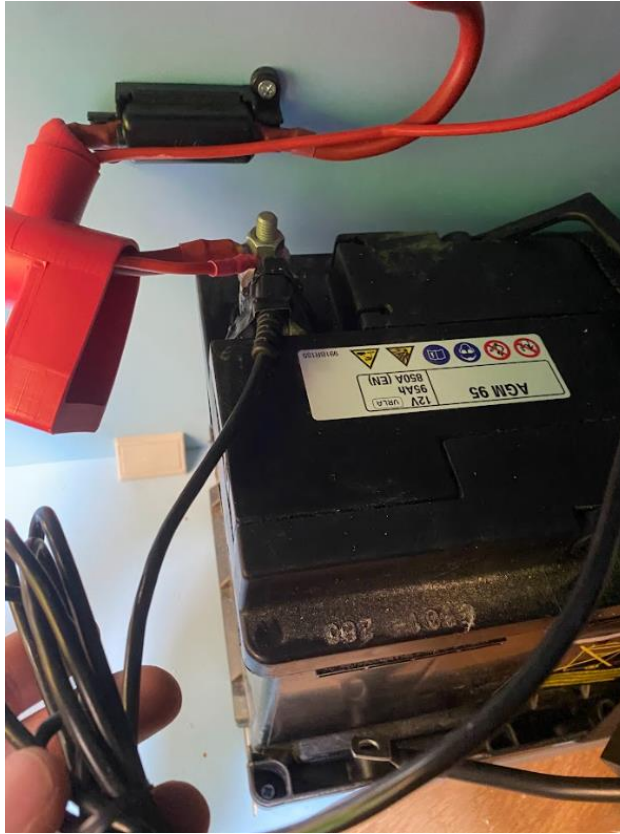

Fit the studs over the terminal positive, then firmly tape the thermometer to the terminal



Fit the rubber terminal and repeat the process for the negative, include the black earth cable

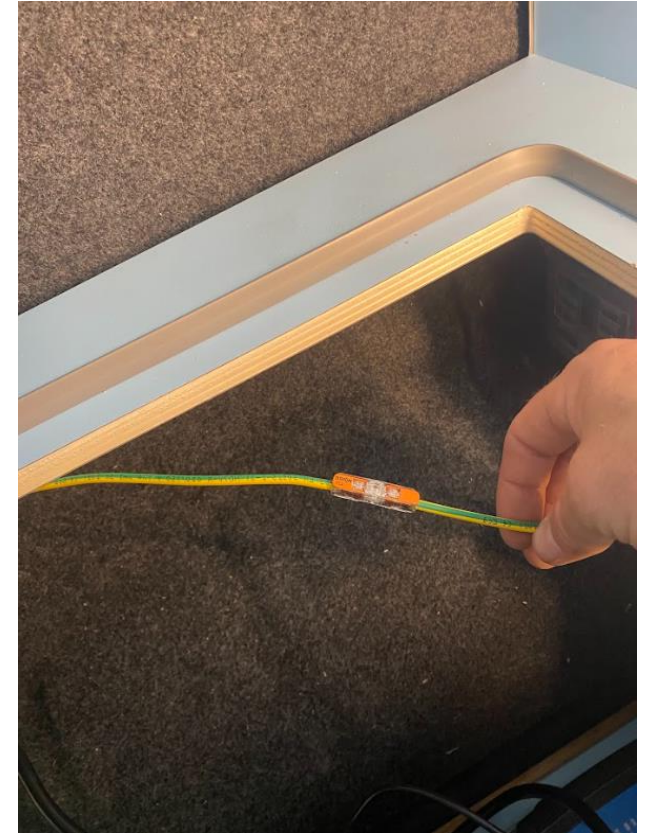

Attach the consumer unit earth with the wago clip



Offer the units into position but do not fit into place

CONNECTING TO THE VEHICLE BATTERY



Firstly, remove the cover above the vehicle battery

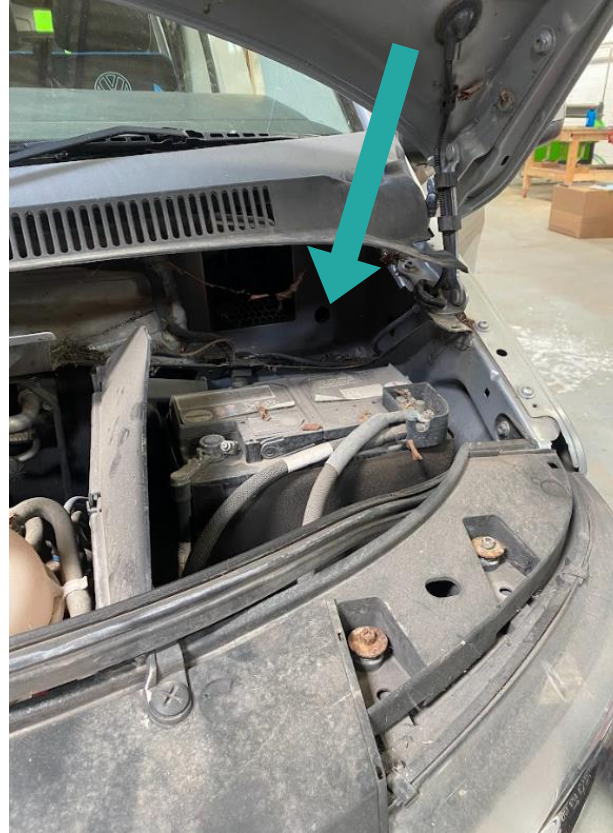

Locate the firewall hole

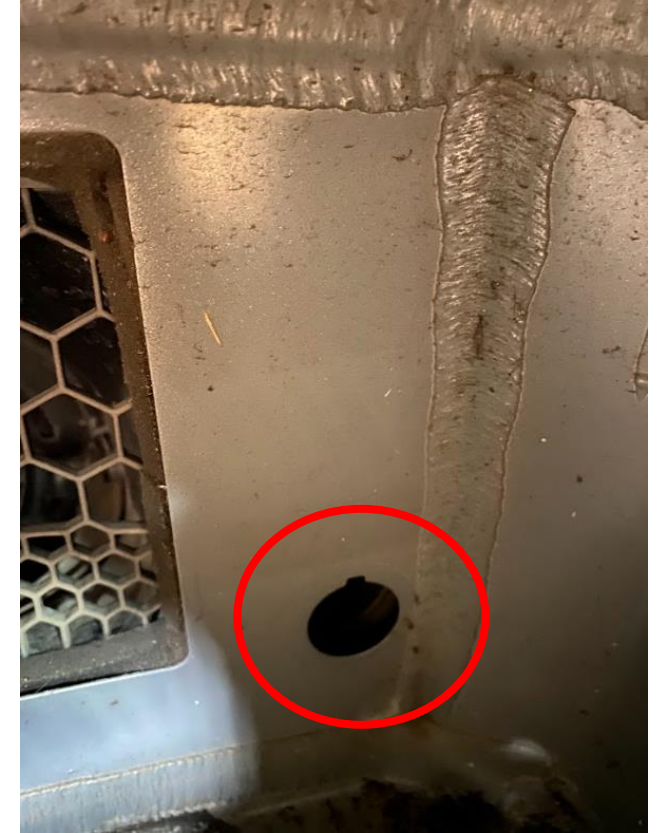

Fit a 25mm rubber grommet

CONNECTING TO THE VEHICLE BATTERY



Cut and fit a rubber grommet to the cover above the battery



Remove the lower panel below the NS glovebox



Feed some guide wire through the hole to establish the path, we have used some old BT cable in the picture

SMART ALTERNATOR

From 2015 the Later T5 BlueMotion and T6 are fitted with variable voltage charging systems that help to reduce emissions, this means conventional VSR relays are no longer appropriate to use. If you have this smart alternator, you will have a third 1mm red cable with a 'piggyback fuse' on the end that will need to follow the path of both the red vehicle battery cable and artic blue 240 cable until slide 115 where you can plug into the fuse board

CONNECTING TO THE VEHICLE BATTERY



Remove the lower panel on the
drivers side



Remove the drivers sidestep

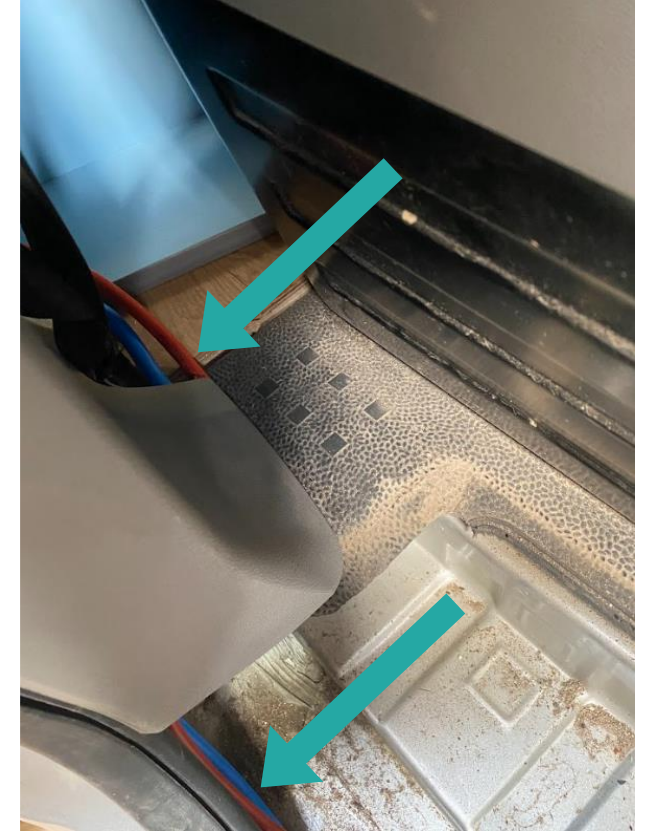

Cable tie the two cables and
feed underneath the pillar trim
into the sidestep

CONNECTING TO THE VEHICLE BATTERY



Continue to feed the cables
along the sidestep



Tape the end of the blue
approximately 2m from
the red end

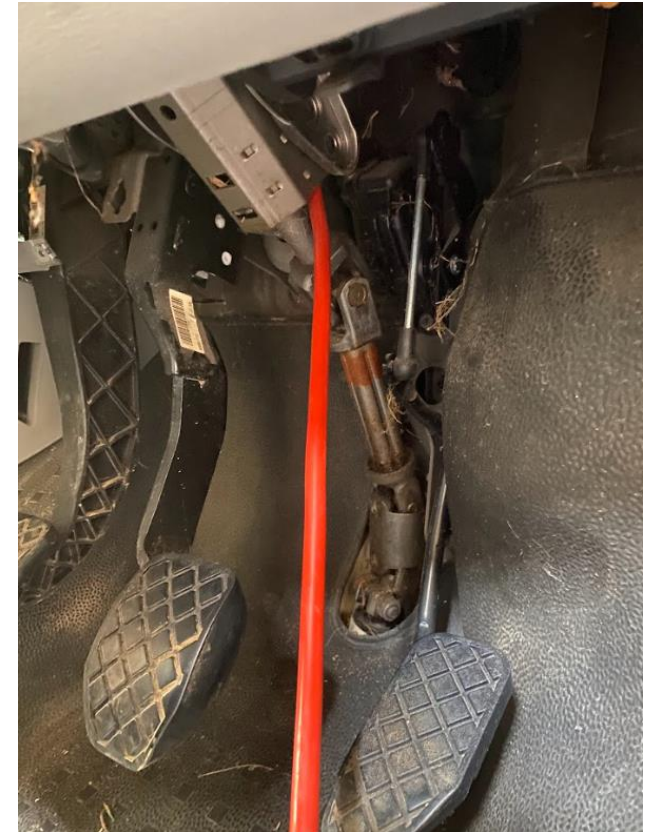

Feed the red end over and
behind the pedals and through
the centre console

SMART ALTERNATOR



Remove the 15amp fuse from the centre column second down



Insert the 15amp fuse into the piggyback and fit in the same location

CONNECTING TO THE VEHICLE BATTERY



Now pull both cables through to the passenger footwell, this stage requires patience!

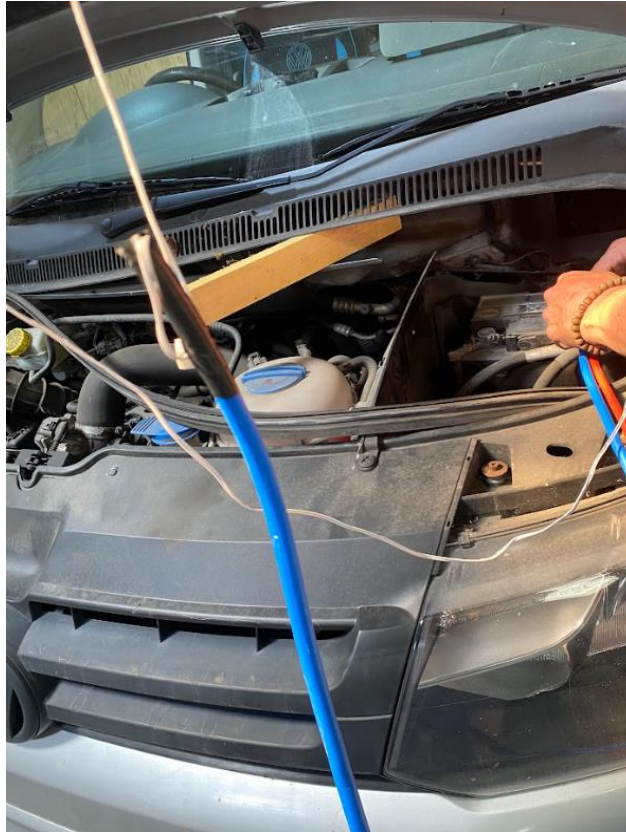

Attach the cables to the guide wire and pull through the firewall hole



Pull both through then remove the guide wire and tape

Before proceeding to connect to the vehicle battery and fitting the 240 hook up, ensure you have stowed away both cables correctly and safely. This is imperative near the pedals, make sure you have cable tied them together; above the pedals as high as possible to one of the pre-existing vehicle looms, safely out the way and *not* impeding any pedal motion. You can now refit the sidestep, rubber trims and panels

CONNECTING TO THE VEHICLE BATTERY

LIVE NEUTRAL



Locate the finish position
of both cables and cut
any excess



Wire the 3 core artic 240
cable to the hook up

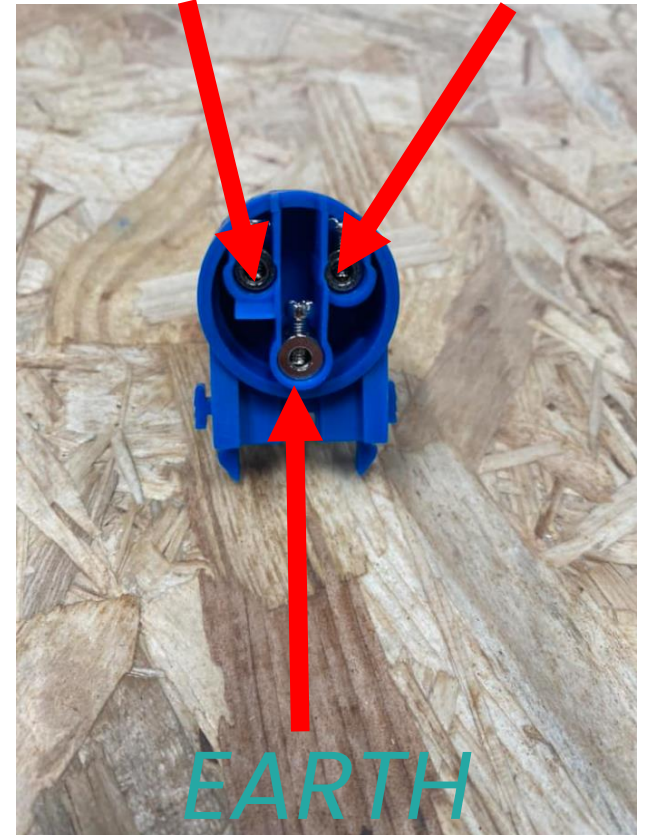

EARTH

CONNECTING TO THE VEHICLE BATTERY



Fit the 240 hook up and screw into position

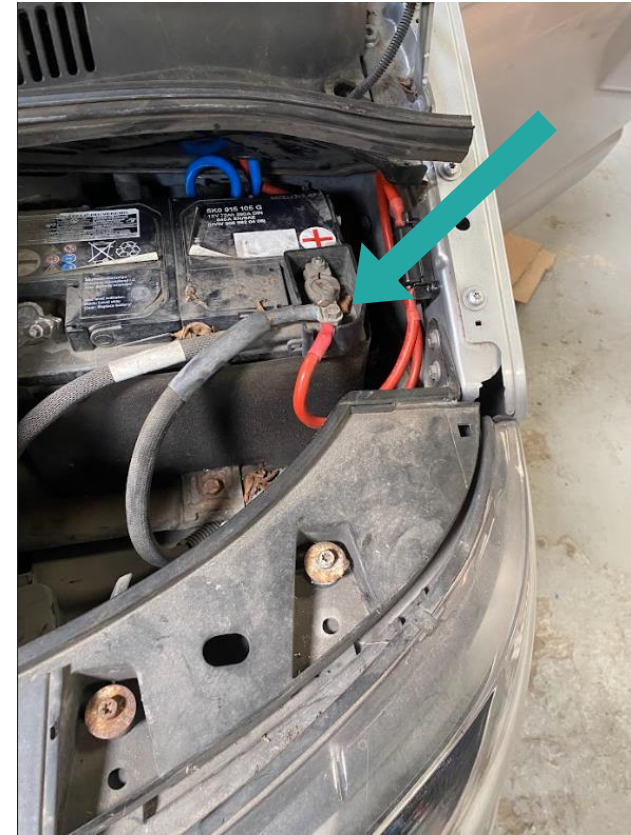

Connect the red split charge cable stud to the vehicle battery live

TEST

Before securing the units to the van, we advise running an electrical test. Check all components are working correctly, if there are any issues, please see page 72. Make sure your consumer unit is on with the breakers in the off position.

FITTING THE UNITS

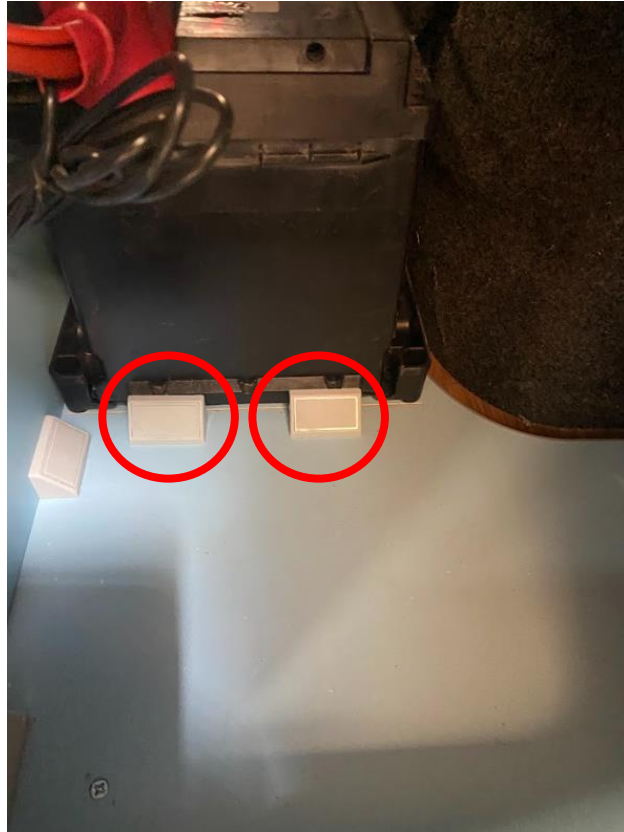

Secure the battery rear with 2 x chock blocks, screw into the base only with 16mm screws



Firstly, fit the rear into position, you will need to pilot drill through the van metal work before fixing, 16mm screws is surfiest



Repeat the process with two chock blocks as seen in the picture

FITTING THE UNITS



Continue to secure the units to the van ply lining, 16mm screws only into the furniture, however 25mm can be more effective into the ply.



Ensure the units are pushed back and as flush as possible. Key tip, attach the block to the unit first, then into the ply

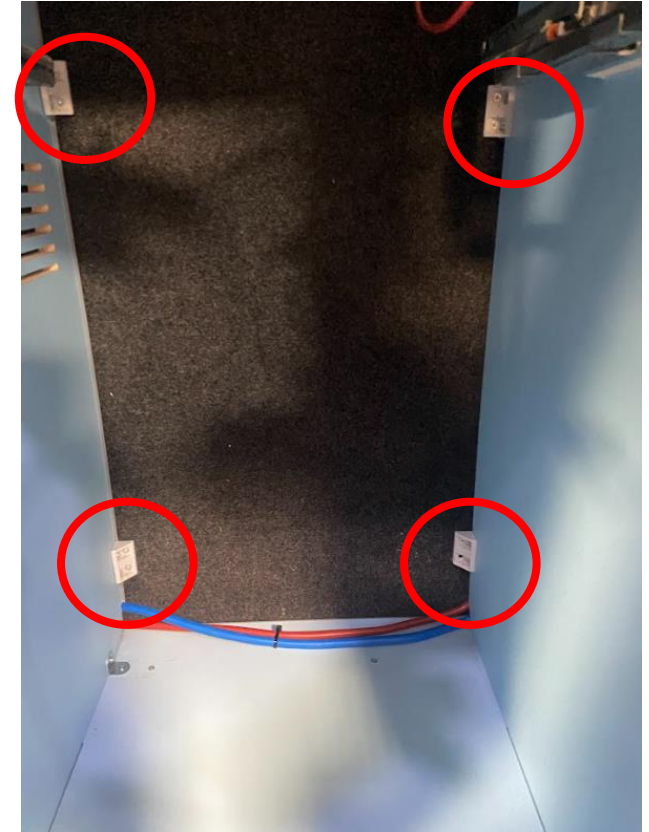

Finally, the fridge pod area, remove the drawer for easier access

FITTING THE UNITS

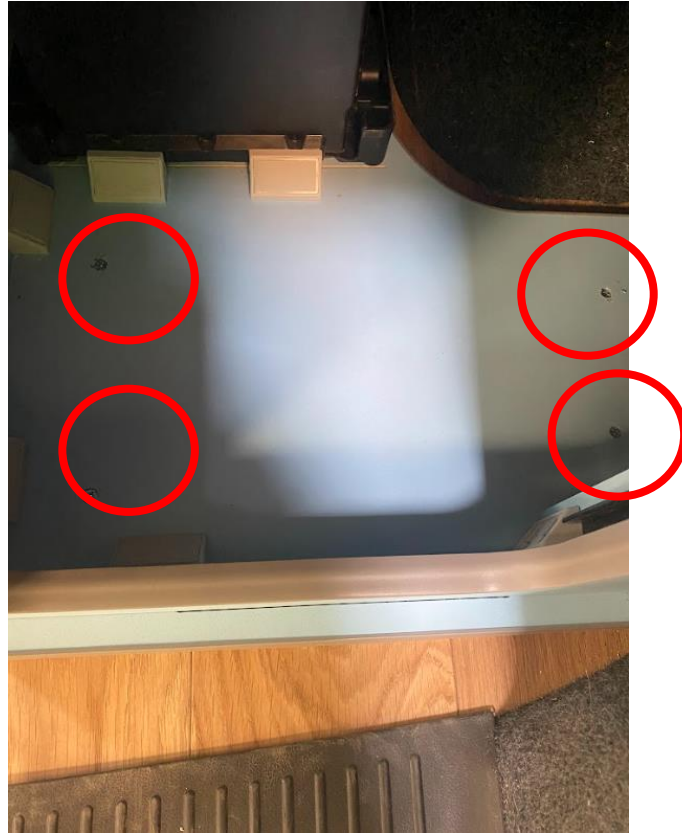

Now screw into the floor using 25mm screws.



Remove the battery access flap in the rear wardrobe to locate the two pilot holes, be mindful of the electrics

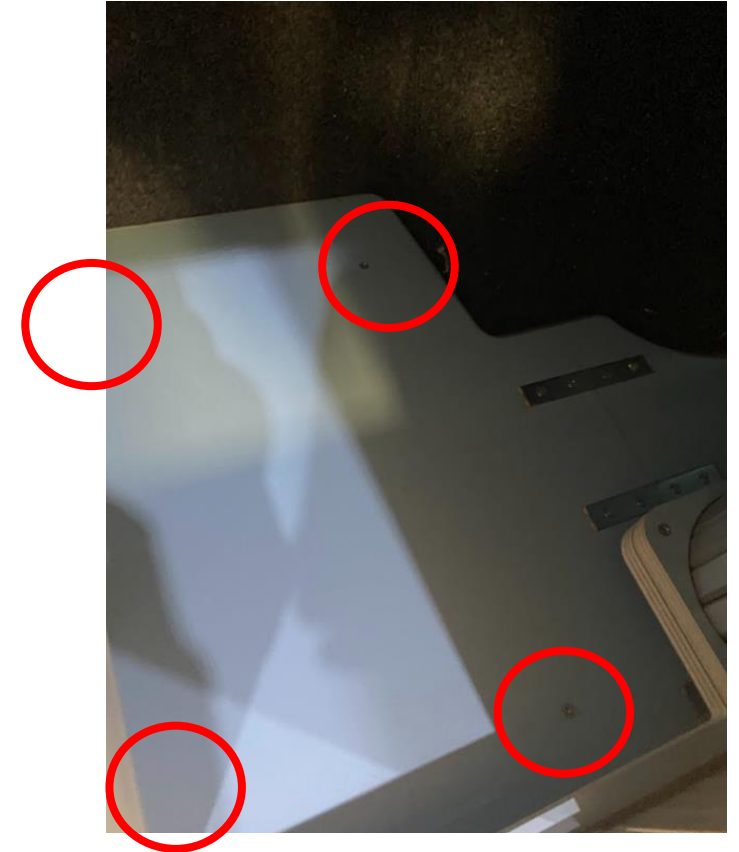

Continue in the main compartment.

FITTING THE UNITS

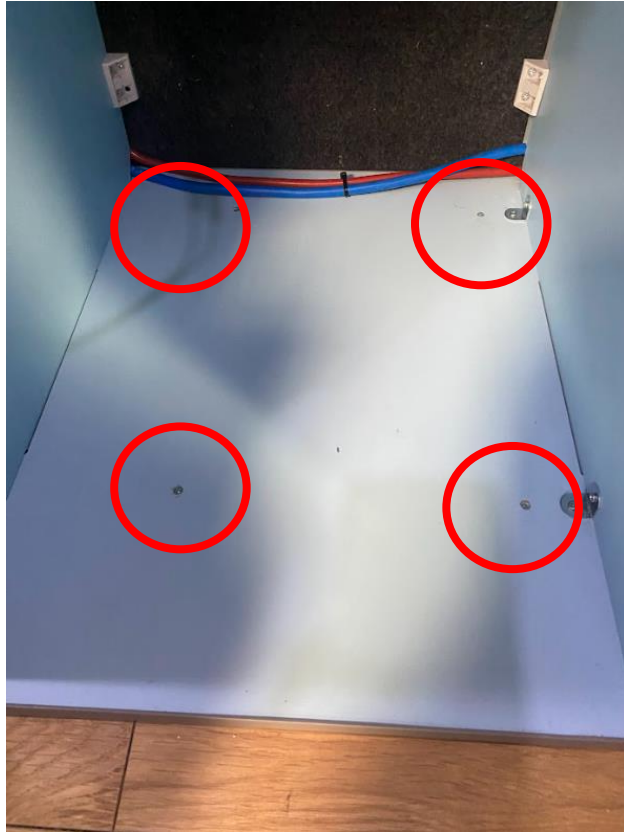

Finally, the fridge aperture .

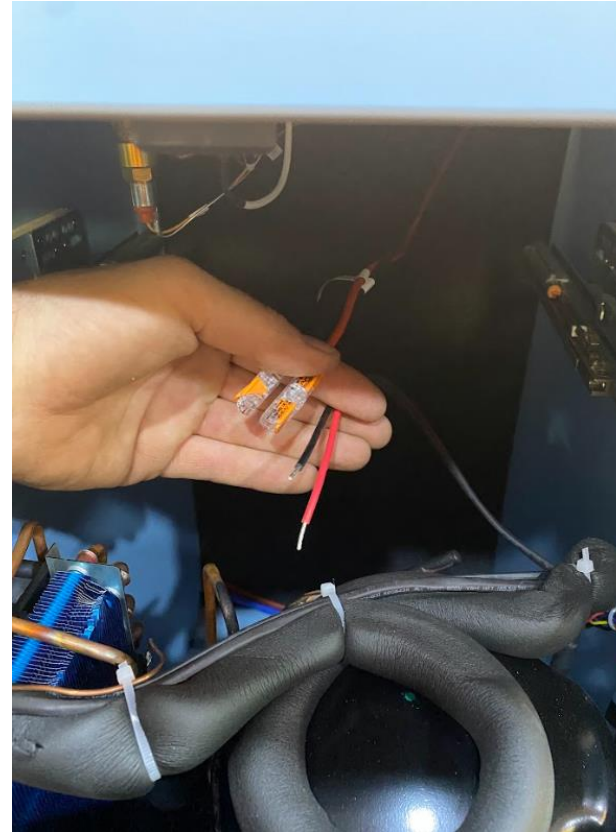

Offer the fridge into position and connect the feeds using the wago connectors, check the fridge is working before fixing



Remove the fridge fixing point caps, screw though into the aperture, use 30mm screws, be mindful not to screw through the ply



COOLWHIP
CAMPER CONVERSIONS

FIND US

Unit 2B
Gallows Park
Millbrook PL11 3AX

CONTACT

01752 423 642
info@coolwhipcampers.co.uk
coolwhipcampers.co.uk

INFO

Mon - Fri
9am - 5pm
Sunday closed