



**COOLWHIP**  
CAMPER CONVERSIONS

*YOUR INSTALLATION INSTRUCTIONS*

# *FTC FLAT PACK FURNITURE*



*INSTALLATION INSTRUCTIONS*

# STOP & READ

Please ensure you briefly read over this instruction manual before attempting to assemble and fit your units. Once you have an understanding of the process, please then read and follow each page step by step, failure to do this can result in mistakes and the process taking much longer.

Please note some pictures contain our Deluxe range and VW T5/6 furniture, however all principles of the instructions remain the same. If you have the Low level or slim line variant kit, these instructions may also slightly differ to your furniture. The slimline is the exact same just in slim form. The low level is also the same, however includes two worktops and two top lockers to accommodate the half height rear wardrobe design. All the information you need is in this manual.

Our integrated floor design allows you to build the units in the comfort of a workshop or garage then simply lift them into the van. This allows for electrical work to be carried out before the units have been fitted. Take care when lifting the units, and never lift from the floor alone as you may snap the join.

These instructions have been broken down into two manuals, the first phase is the construction of the furniture, the second is the 'Plug & Play' electrical and appliance installation. Please ensure you follow in order.

# THE PROCESS

Read instructions and  
prepare work space and tools



Oil the edges and  
Oak



Prep work such as  
hanging doors and  
fit handles

Assemble



Electrics



Fit

# STOP AND READ

Ensure you only use **15mm screws** provided, or screws that come with hardware such as drawers and hinges

When using 25mm screws pilot drill first and never counter sink (unless stated otherwise)

Failure to do the above can result in screwing through the outer side of the material



# OILING

It is extremely important to treat the edges of your ply and Oak products. Failure to do this can result in bowing and delamination due to moisture ingress.

You can apply an oil, a varnish or wax. We recommend Osmo topoil, there are a few shades of colour available. The oil also passes health and hygiene standards for worktops and works well on the ply edges.

Treating your edges also makes for a beautify finish



**Quick tip** – sand down all edges before oiling for a cleaner finish



Apply two coats of oil to the edge of every piece of furniture, allow the correct drying time, clean of oil off the laminate face as you go

# OILING

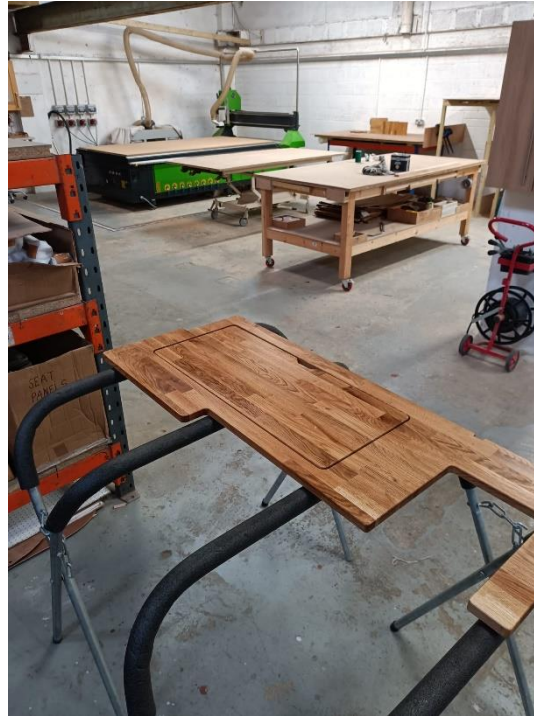

Repeat for the Worktop and handles, ensure to seal every exposed edge

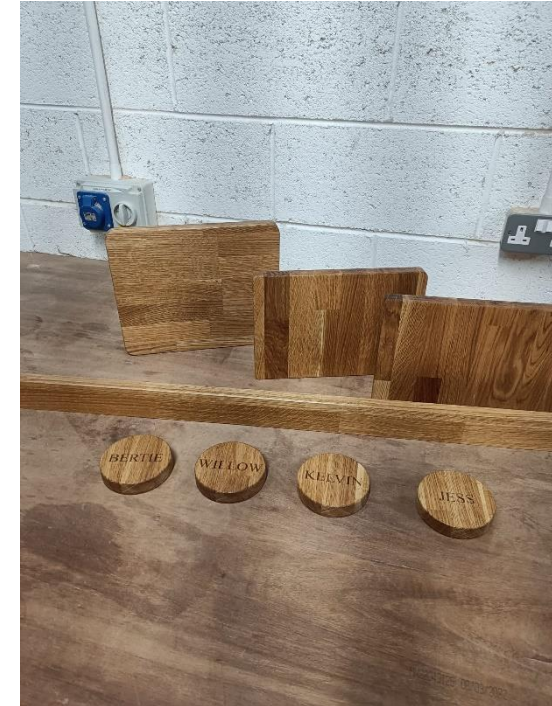

Allow to dry and apply two coats

# HANGING DOORS

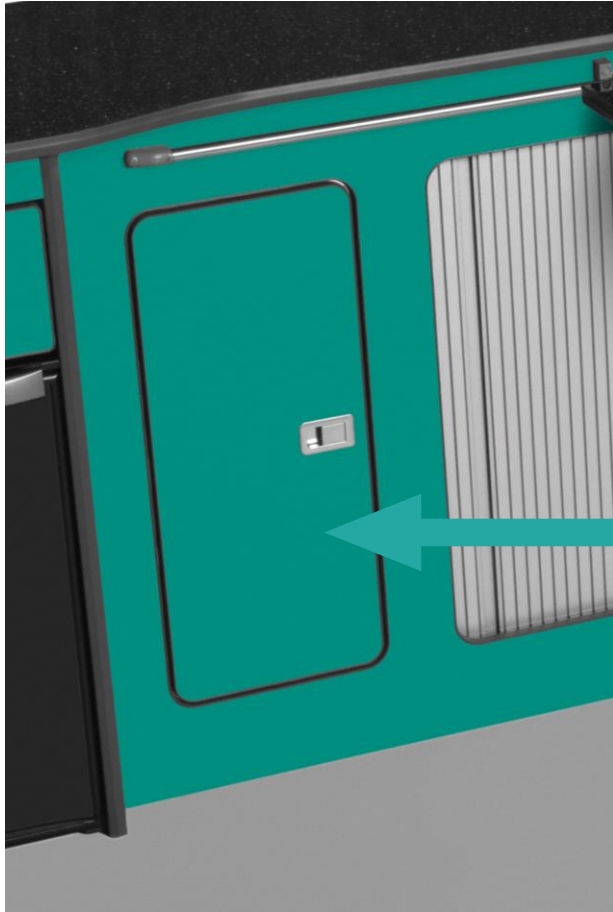

## TOOLS

- Drill Driver
- Stanley knife
- Cross head Screw driver





# HINGES



Fix the hinges to the door only using 15mm screws and the pilot holes provided



If your hinges have the cover plates clip them on



Turn the adjustment all the way to the rear before fixing to the aperture

(CONT.)

# HINGES



Remove Euro screws (if necessary) and replace with 15mm screws to fit the plate to the aperture

HORIZONTAL  
ADJUSTMENT

OVERLAY  
ADJUSTMENT

CLIP-ON  
MOUNT

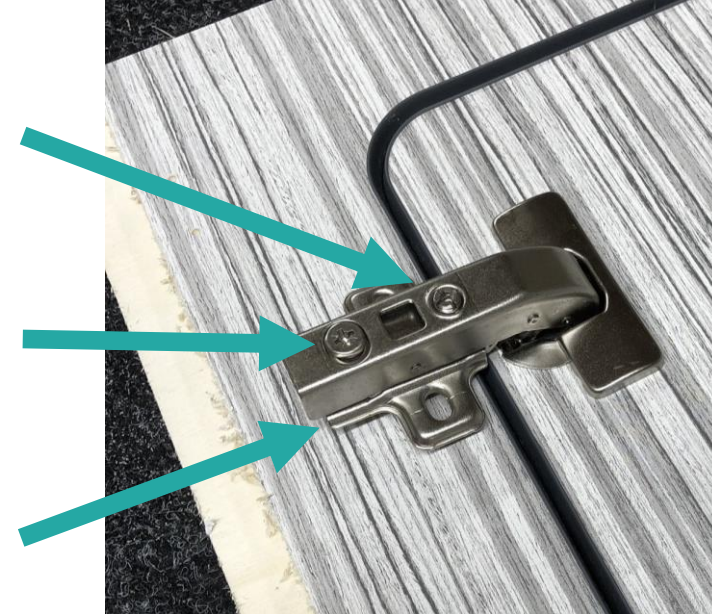

Once both hinges are fitted, adjust the door to fit flush with equal spacing

# *HANGING DOORS*

## *CHECK & MAKE SURE...*

The doors sit flush and open and close correctly

Now follow the same process and hang all doors



(CONT.)

# HANDLES



Fit the handles using the  
25mm bolts



Align the holes with the  
pre-drilled holes on the  
doors and tighten



# *SOFT CLOSE DRAWER ASSEMBLY*



(CONT.)

# SOFT CLOSE DRAWER ASSEMBLY



Attach the mounting clips



Fit the drawer rear using  
15mm screws



Fit the drawer base using  
15mm screws, ensure the  
base is flush to avoid gaps

(CONT.)

# SOFT CLOSE DRAWER ASSEMBLY



Fit the drawer face catch



Screw the drawer face mounts into the pilot holes with the 4 x large head screws provided with the drawer box



Clip the face into the side runners

# DRAWER RUNNERS



Fit the runners using the pilot holes provided, ensure you have the correct runner on each side. Repeat on opposite fridge pod





(CONT.)

# FLOOR ASSEMBLY

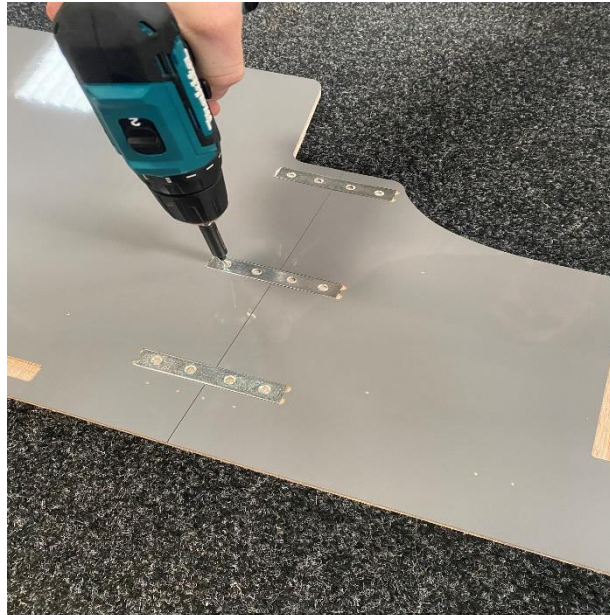

Screw the floor together with the fixing plates using 15mm screws

# WARDROBE ASSEMBLY



## TOOLS

- Drill Driver
- Mallet
- Stanley knife
- Sand paper
- Cross head Screw driver
- Tape Measure
- Set Square



(CONT.)

# WARDROBE ASSEMBLY

## OVERVIEW

The wardrobe is the most time consuming part of assembly

Its important you follow each step in order of instruction

Use 15mm screws unless directed otherwise

We recommend two people

You will need a large clean flat surface

Do not counter sink 25mm screws and **do not counter sink**

(CONT.)

# WARDROBE ASSEMBLY



Firstly, stick the wardrobe LED into the profile and re attach the cover case (only included in the Plug and Play)

(CONT.)

# WARDROBE ASSEMBLY

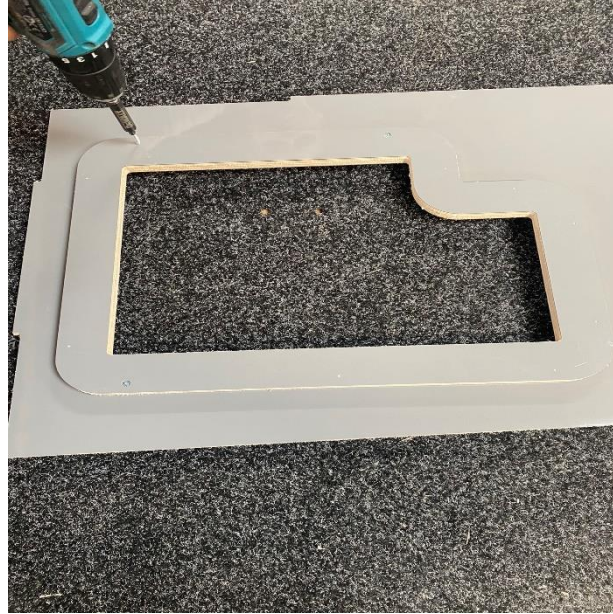

Fix the wardrobe bottom shelf inner to the underside of the shelf using 25mm screws, this will seat the battery access flap

(CONT.)

# WARDROBE ASSEMBLY



Place the wardrobe face down



Slot the bottom shelf, divider  
and lid shelf into the rebates  
DO NOT SCREW



Fit the wardrobe upright (L)  
first, start from the base  
working up to the top using  
the blocks and pilot holes

(CONT.)

# WARDROBE ASSEMBLY



Fit the wardrobe upright (R) start from the base working up to the top using chock blocks and pilot holes

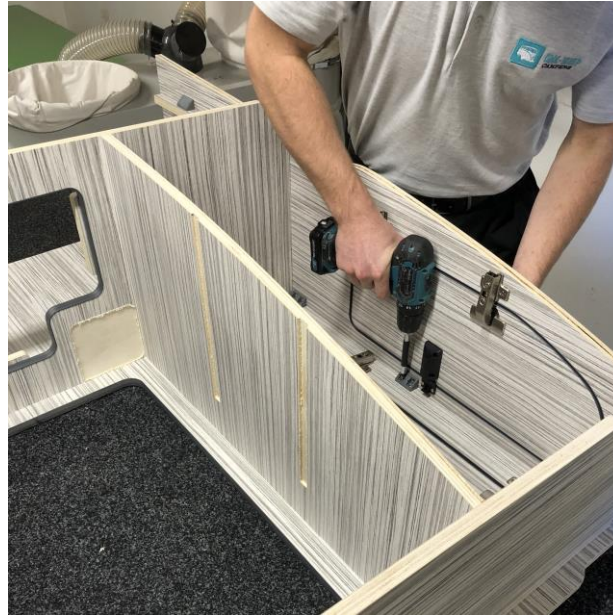

Ensure piece sit together nicely

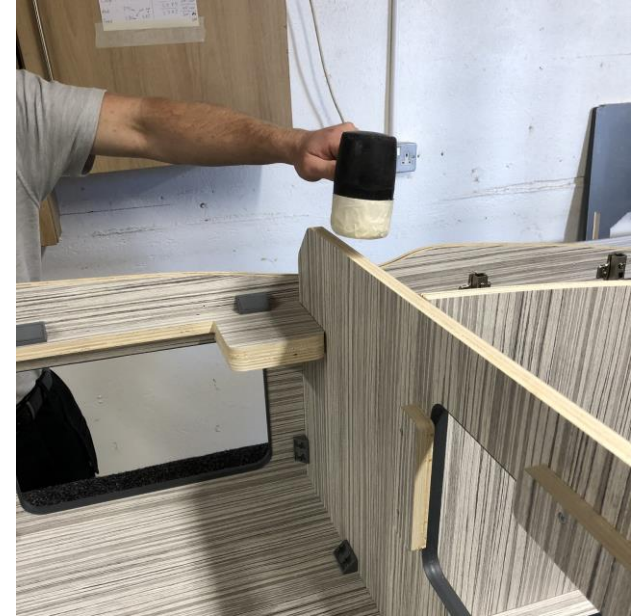

Ensure the bottom shelf is seated correctly before fixing

(CONT.)

# WARDROBE ASSEMBLY

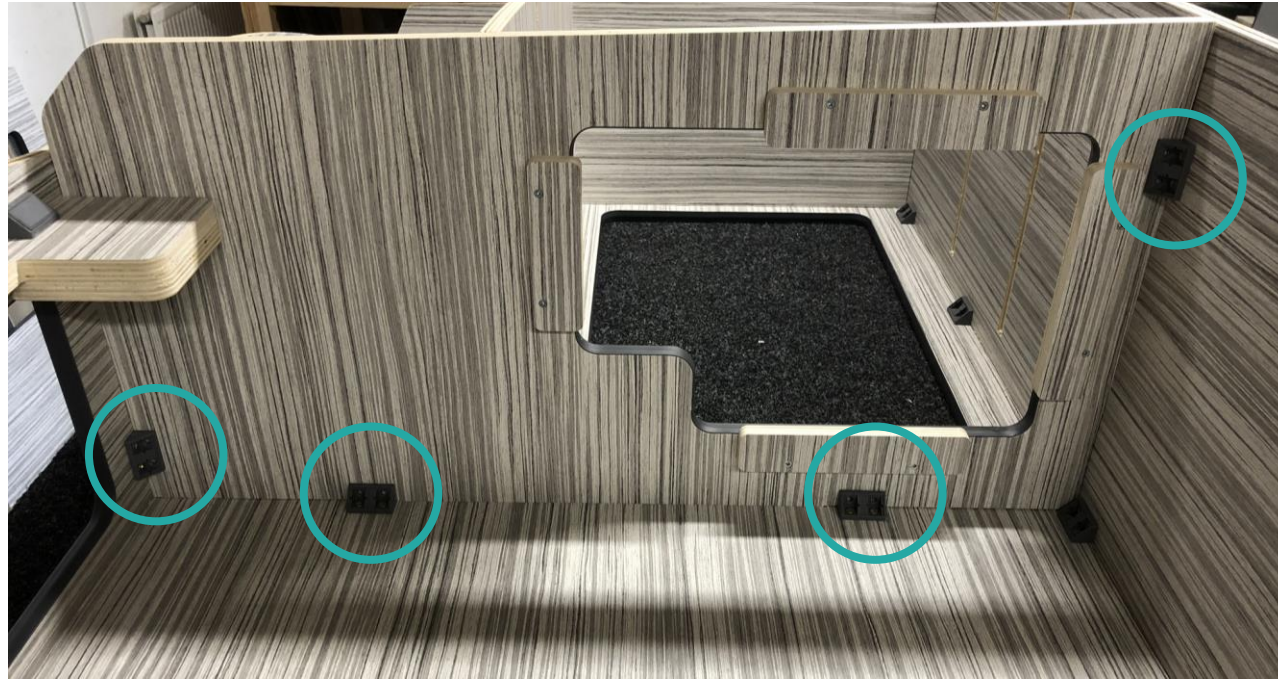

Screw the bottom shelf together using the blocks and pilot holes provided, ensure the joins are tight and flush



(CONT.)

# WARDROBE ASSEMBLY

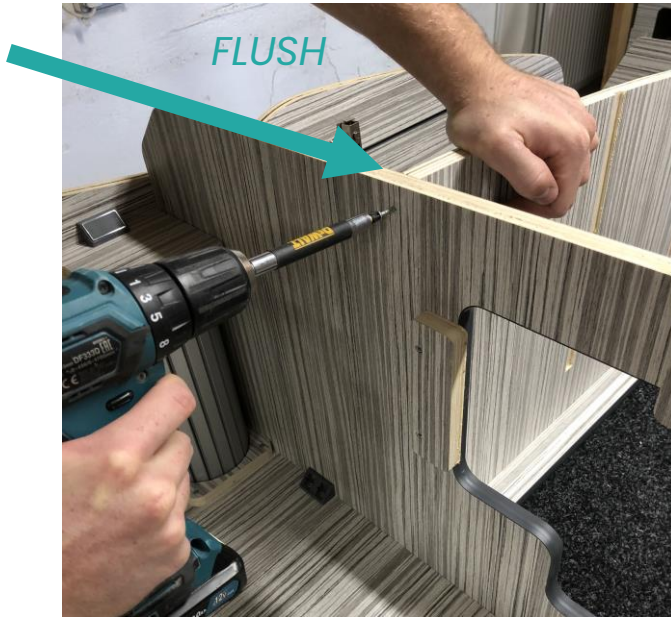

Screw through the bottom shelf into the divider using a 25mm screw\*



Fit the lid shelf to the upright (R) ensure the joints are tight and flush



Secure top of divider with a block

\*You may countersink

(CONT.)

# WARDROBE ASSEMBLY



Repeat the process with  
the left upright



Now screw the lid shelf to the face.  
Please note, your blocks may be  
underneath the lid shelf

(CONT.)

The next stages see the units finally coming together, place the base into the centre and front of the van, then continue onto the next slide.

For the purpose of these instructions and taking relevant pictures, we have continued to build outside the van



(CONT.)

# WARDROBE ASSEMBLY



Stand the wardrobe up click into the floor rebates.



Fix the wardrobe to the floor using 15mm screws, and pilot holes provided



Continue

(CONT.)

# WARDROBE ASSEMBLY



Screw the large tambour door wheel (R) to the bottom shelf using 25mm screws



Repeat the process with the opposite wheel on the lid shelf



Insert the tambour door into the wheel runners from the rear

(CONT.)

# WARDROBE ASSEMBLY



fit the bottom track 14b into the tambour wheel as far as it will go. Once happy with the position, glue into place



Repeat the process for the top track



Screw the Tambour housing together and slide into position before fitting the tambour shelves (finger gap at the front)

(CONT.)

# WARDROBE ASSEMBLY



Fit the wardrobe shelves by sliding into the rebates and fixing with chock blocks underneath



Fit the blocks for the Wardrobe rear shelf

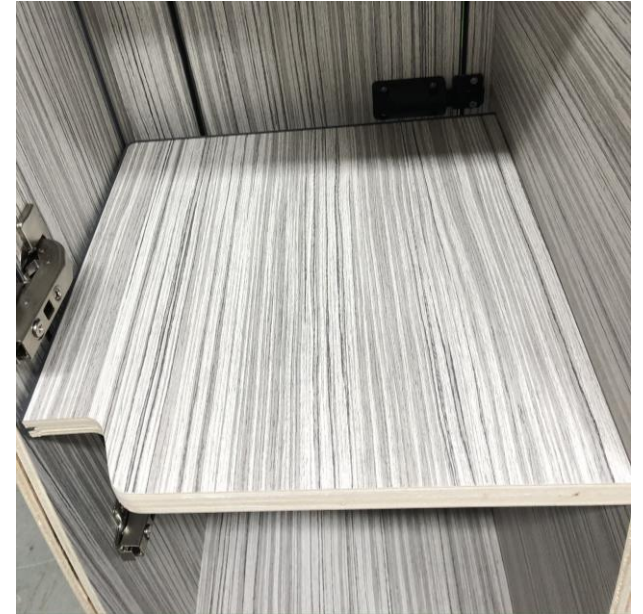

Fit the Wardrobe rear shelf flush with the rear

(CONT.)

# WARDROBE ASSEMBLY



Finally slide the cubby  
hole insert into place



# ASSEMBLY



Fit the Kitchen unit face  
from the rear



Ensure the face is flush  
with the wardrobe



Fit the shelf blocks

# ASSEMBLY



Fit fridge pod (R) from behind, if you have the new twin door design fit with 1 x block at the top using the pilot holes



Fit the Kitchen unit shelf

# ASSEMBLY



Fit blocks to the flap divider and fit to shelf using the rebate



Now fit the rear support into place, be sure to have it the correct way



Now fit the fridge pod upright (L) and click rear support into place

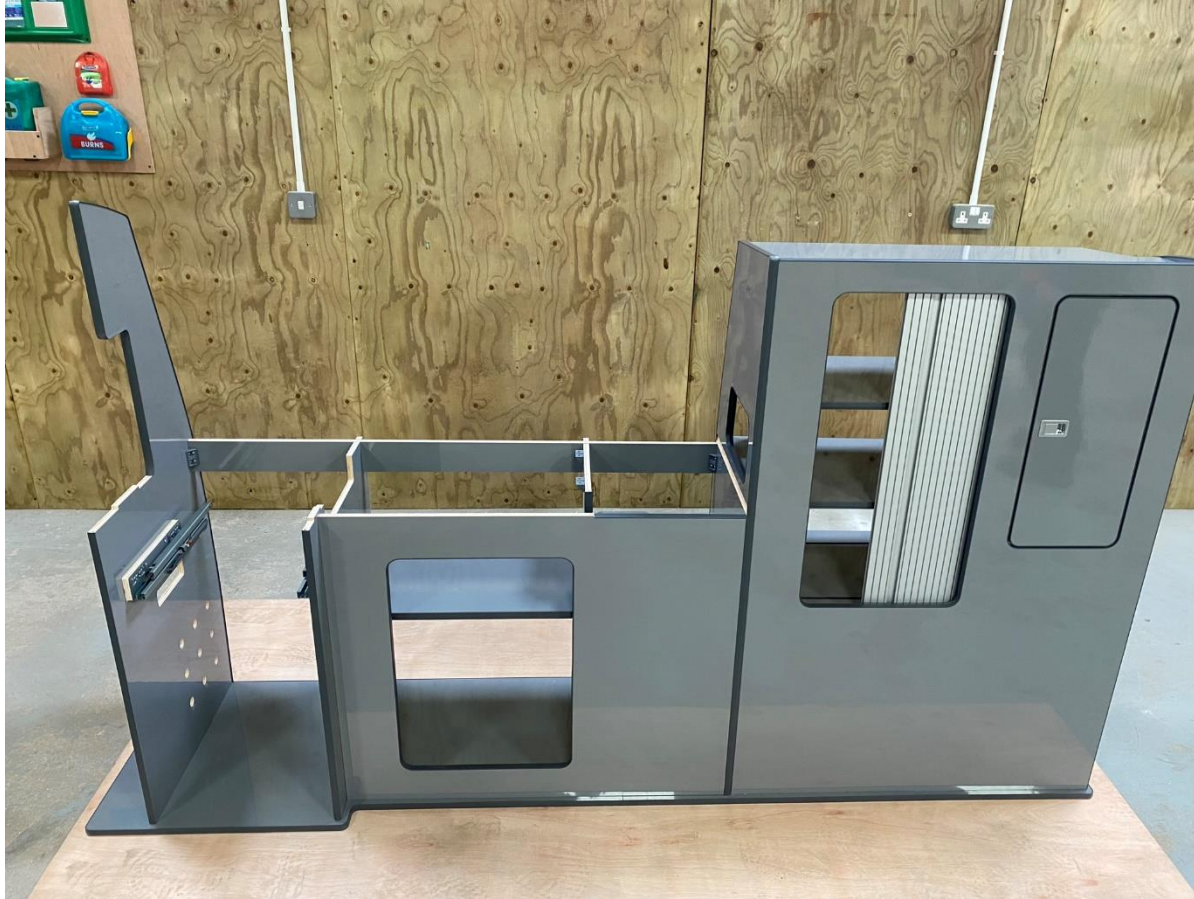

# ASSEMBLY

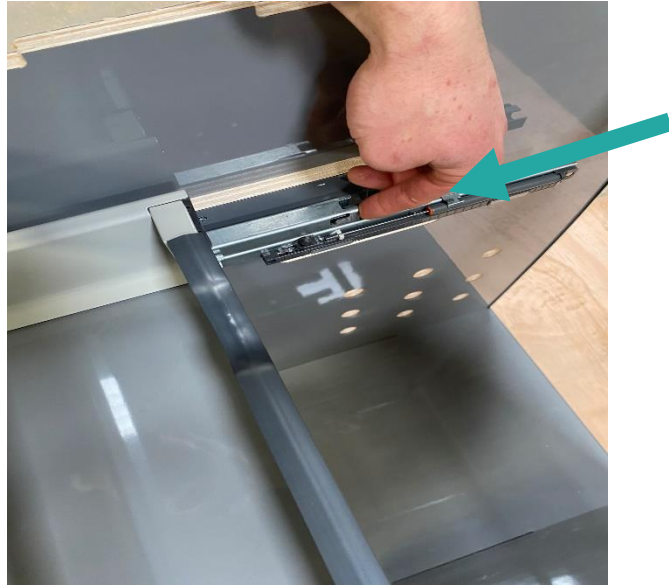

Fit the drawer to the runners, there is an audio click when the runners are pushed in correctly

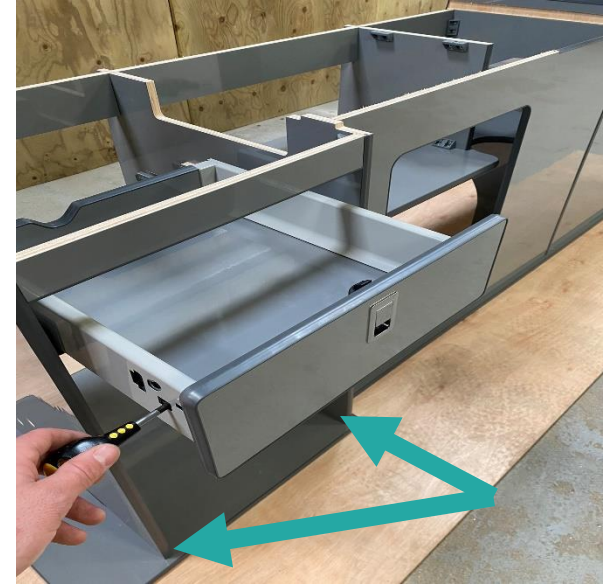

Adjust the drawer to fit perfect, ensure both fridge pods are equally 15mm from the base front

# ASSEMBLY



Fit the fridge door using overlay hinges



Fit the left under sink door using cranked hinges

# ASSEMBLY

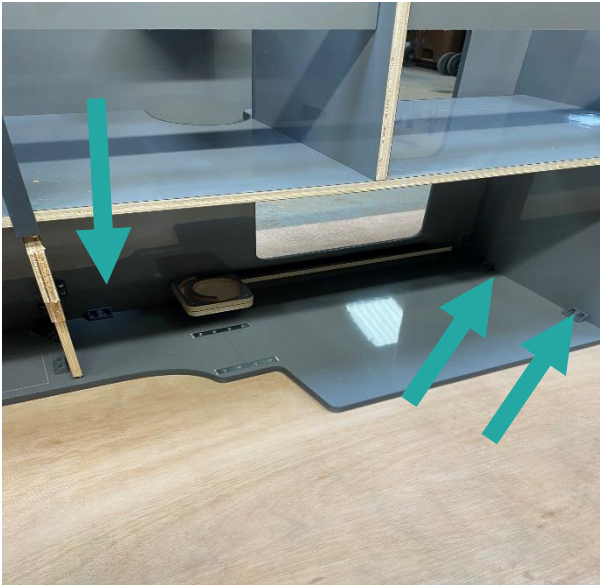

Continue to screw the units to the floor, ensuring the face is inline with the cupboard 15mm from the floor edge



Fit the fridge upright (L) to the floor using 2 x small L brackets on the inside of the aperture, do not use blocks as they obstruct with the fridge



Fit the right side table storage holder to the outside front of your fridge pod (L) with 15 mm screws

# WORK TOP



This template will house the sink/ grill and allow for the cut out to sit on top flush.

Fit the grill seating template to the underside of the worktop. Align the template with the marked out area.

Dress the straight side of the template with the worktop front with the ply smooth side up. Screw into position around the perimeter using 30mm screws, roughly every 150mm apart and 10mm from the edge. Ensure to pilot drill.

*Straight side =  
Front of worktop*



# WORK TOP



Using the alignment rebates, drop the worktop into place. Start by offering the right of the worktop into the wardrobe rebate, then simply find the rebates and seat correctly. Do not forget to fix down with blocks and 15mm screws

# DOOR CATCHES



First fit the magnet to the return face, use the floor for doors under the worktop



Offer the strike plate to the magnet for correct positioning, mark the two holes



Pilot drill the two holes with a 2mm bit and screw the plate using the screws provided. Do not screw too near the edge as the ply can split

# DOOR CATCHES



For 90-degree hinge doors such as kickboards and the slimline bottom wardrobe door, fit the return block into the rebate using a chock block, this will provide a return to fit the magnetic hinges as before

# TOP LOCKER ASSEMBLY



# TOP LOCKER ASSEMBLY



Screw the two top locker dividers together

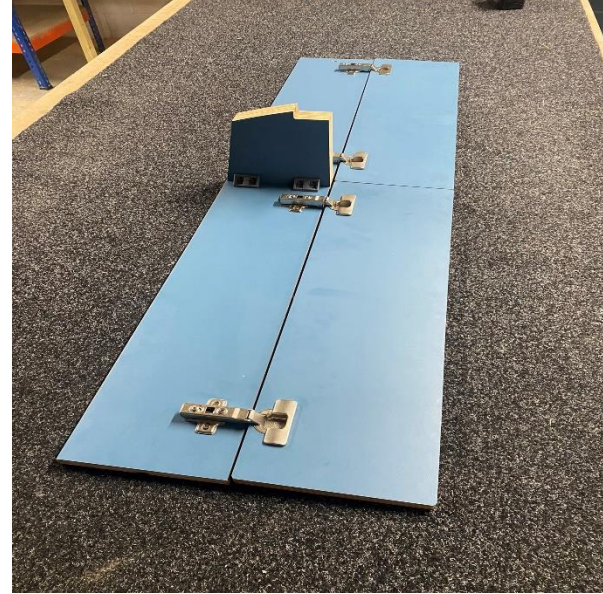

Fit the top locker hinges to the doors and attach to the base, then fit the dividers into the rebate

# TOP LOCKER ASSEMBLY



Fit two 2 x chock blocks to the top locker support



Fit both end panels, use the pilot holes to align in the correct position

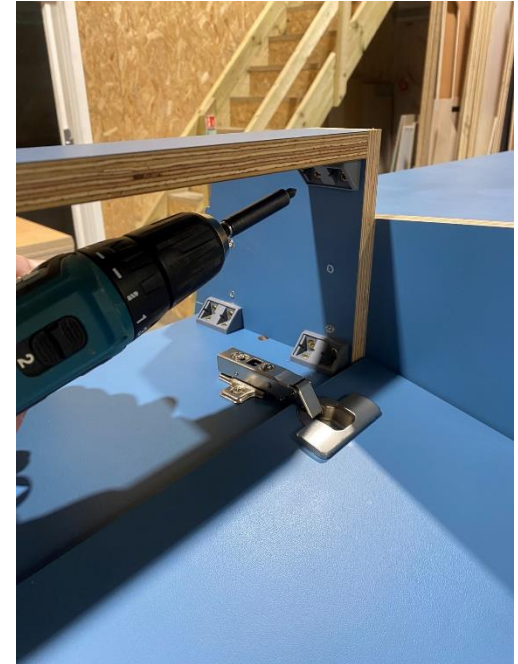

Fit the top locker top support across the top of the locker, we fit the locker after the units

*If you have purchased furniture only skip to slide 83 for fitting*





**COOLWHIP**  
CAMPER CONVERSIONS

*ELECTRIC PACKAGE  
INSTALLATION INSTRUCTIONS*



# STOP & READ

Please ensure you briefly read over this instruction manual before attempting to fit the electrical components and looms to your units. Once you have an understanding of the process and feel confident carrying out the install, please read and follow each page step by step, failure to do this can result in mistakes and the process taking much longer.

For the purpose of this manual, we have carried out this phase outside the van, once again for ease of demonstration and to take better pictures

# THE PROCESS

Read instructions,  
prepare workspace  
and tools



Sink/ grill  
combo



Fit electrical  
components  
and loom



Fit earth cables to  
van earth point



Connect to  
Leisure battery



Secure the  
units



Connect to  
Vehicle battery &  
240 hook



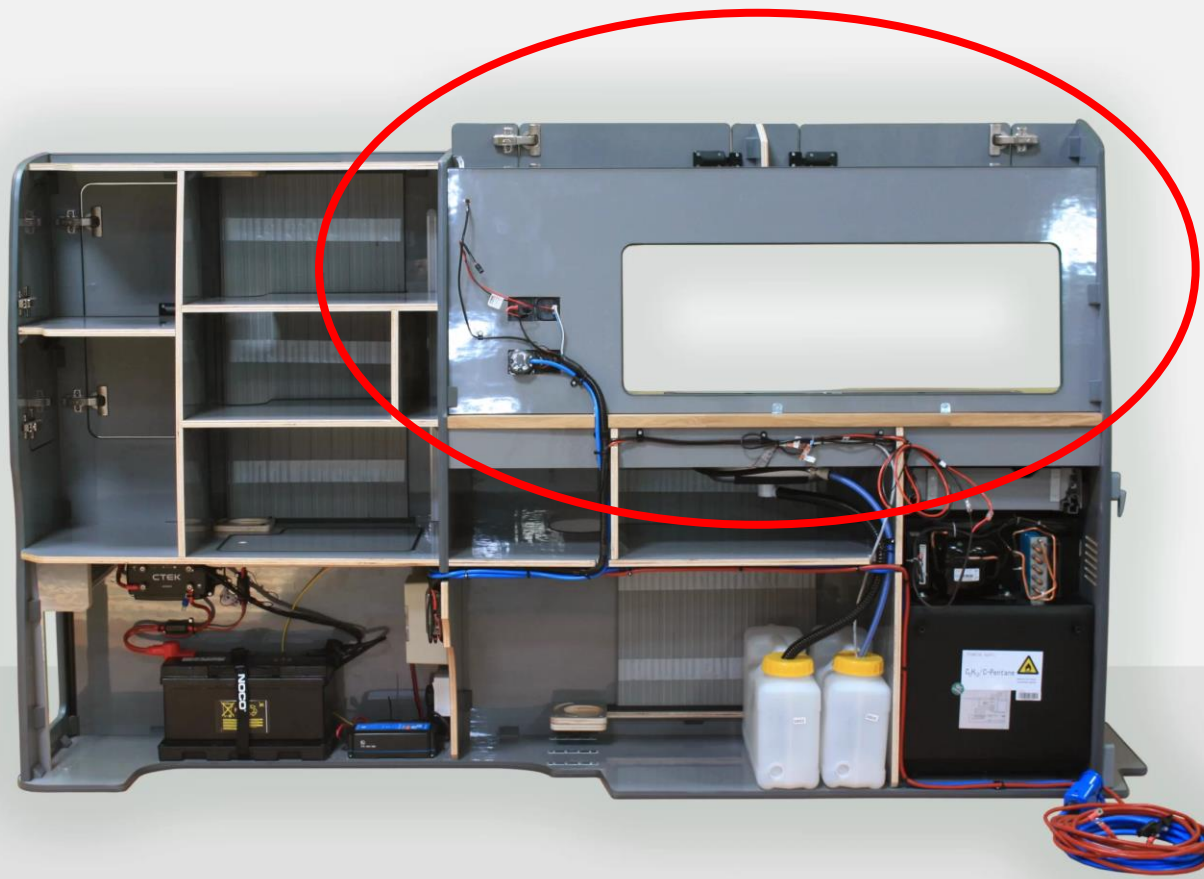

See left VW T5, the Ford transit custom differs here; the top locker, splashback and control panel are fitted separately towards the end

# DISCLAIMER

Please note, this instruction manual is a guide to how we recommend the following stages are carried out. Although the looms and components are prewired and labelled, you will require a basic understanding of electrics. If you are not confident in this process, we recommend seeking advice or help from a professional.

All components and looms are pre-tested on our mock up kit to pass quality control before leaving us, any issue that arises will be a result of incorrect assembly and will require a fault-finding process. For example, the entire electrical loom may not be live due to one simple loose connection. Please ensure you have followed the steps correctly.

Although we may be able to advise, we are a product-based company, all components are brand new and tested. If you are still unable to diagnose where any electrical issues are, we recommend seeking advice or help from a professional.



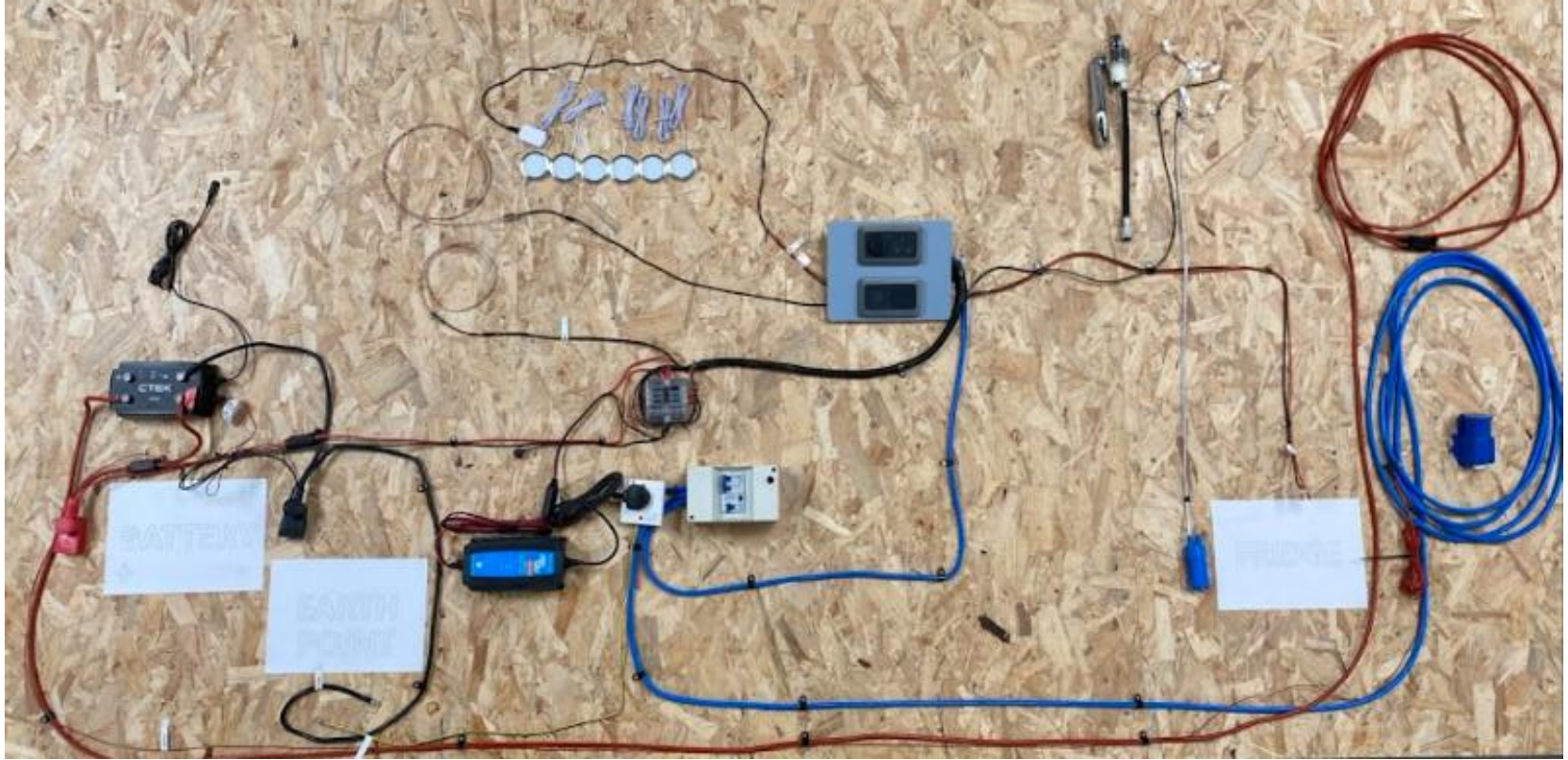

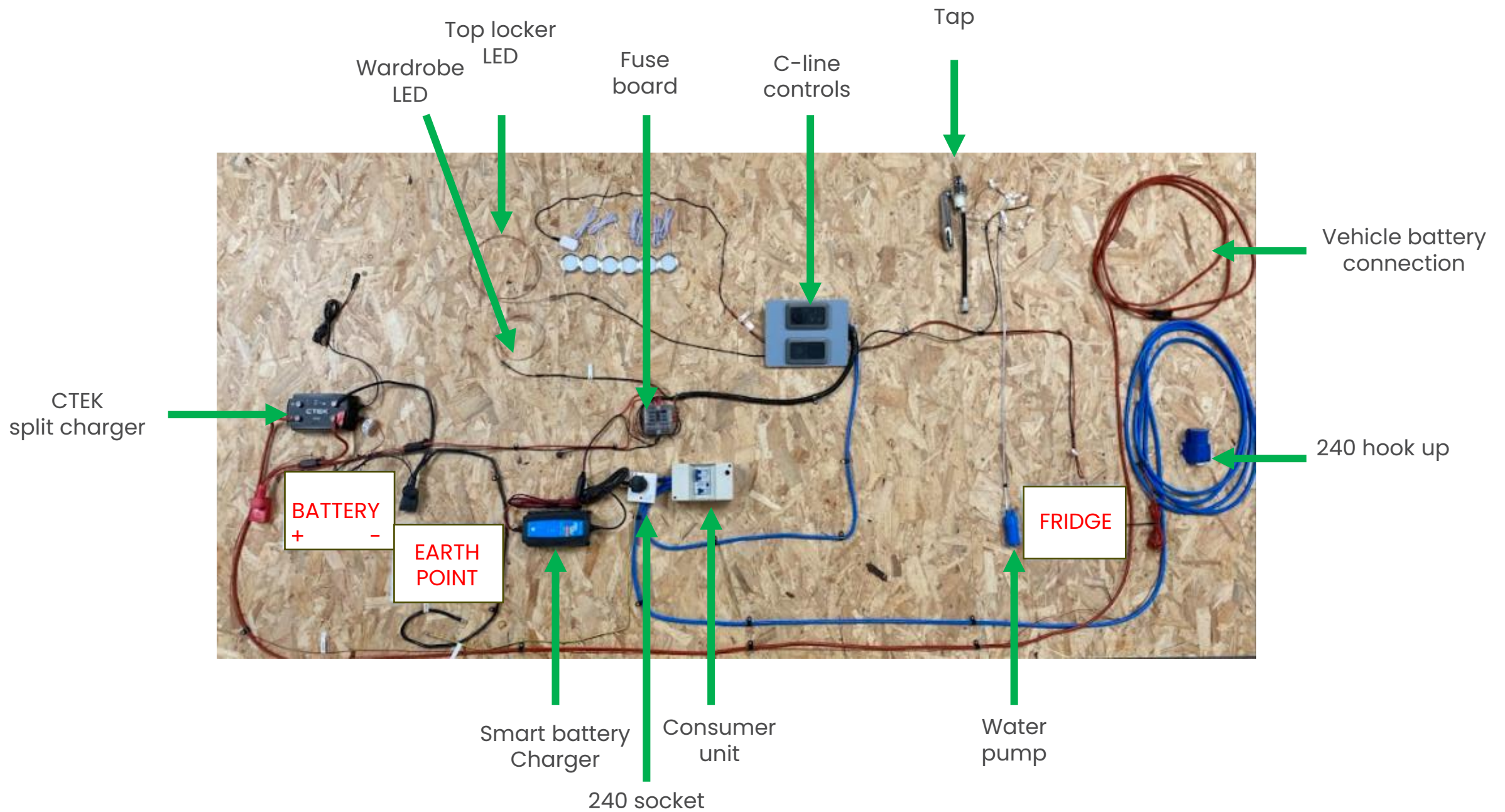

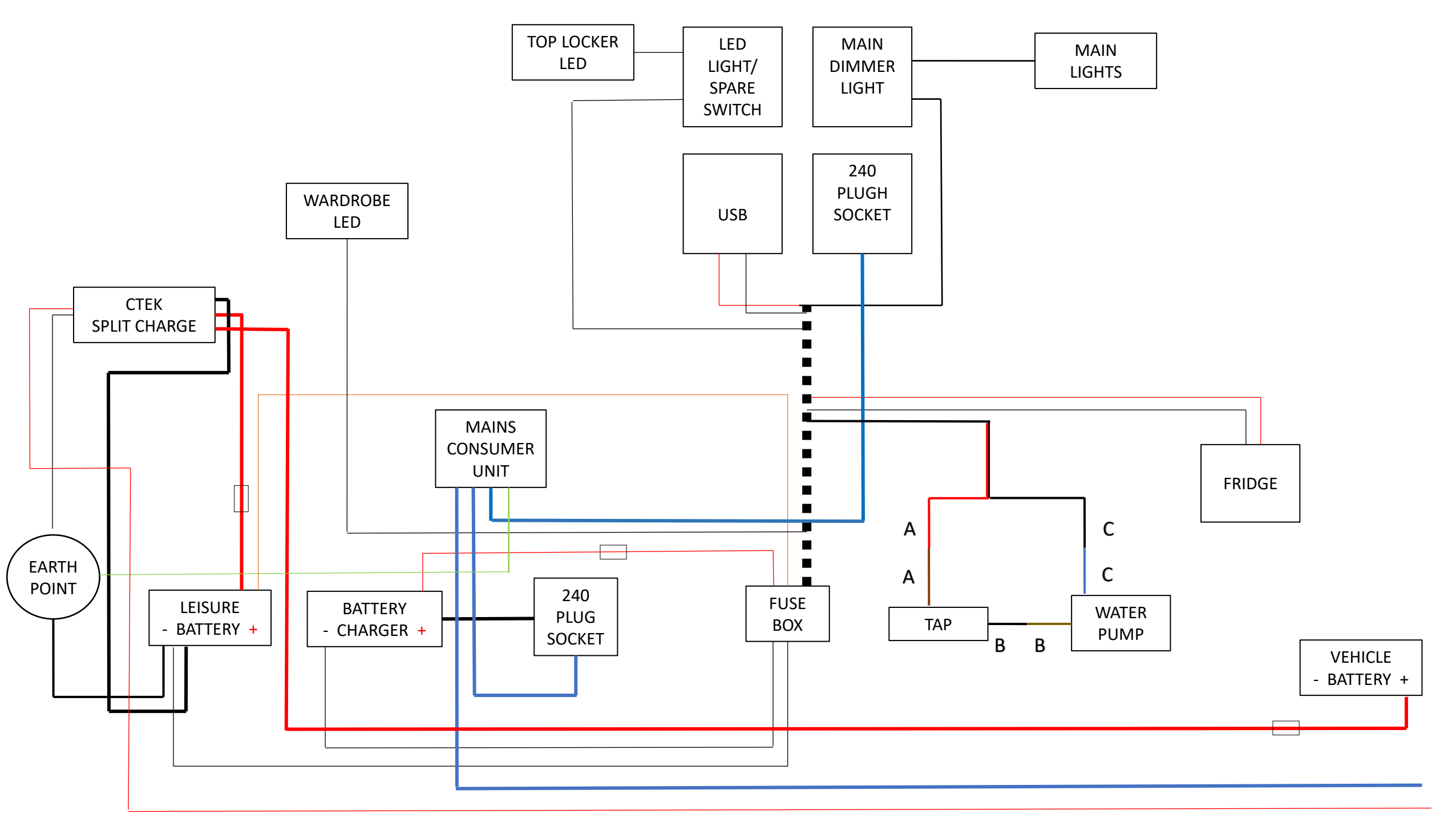



# VAN EARTH POINT



Your electrical kit will need earthing to the vehicle, therefore locate a suitable earthing point below the height of the wardrobe bottom shelf in the O/S rear quarter and attach the earth cables. You can do this now then attach to the battery later, or attach to the battery then earth when in the vehicle

# SINK/ GRILL COMBO



Remove the protective masking tape



Fit the rubber edging, cut on completion and butt together

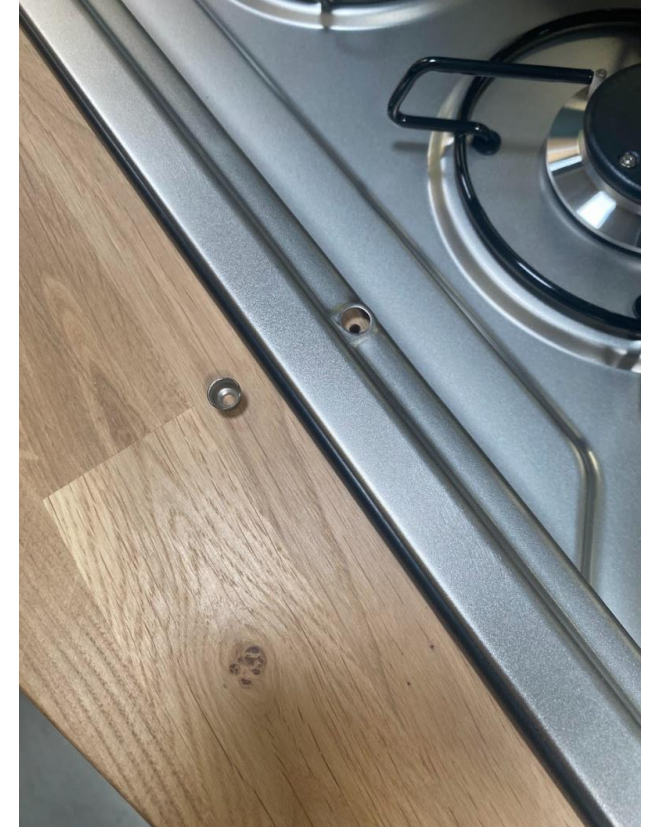

Insert the grill to the underside template. Fit the screw inserts

# SINK/ GRILL COMBO



Screw into the worktop using the screws provided with the appliance



Fit the black screw caps

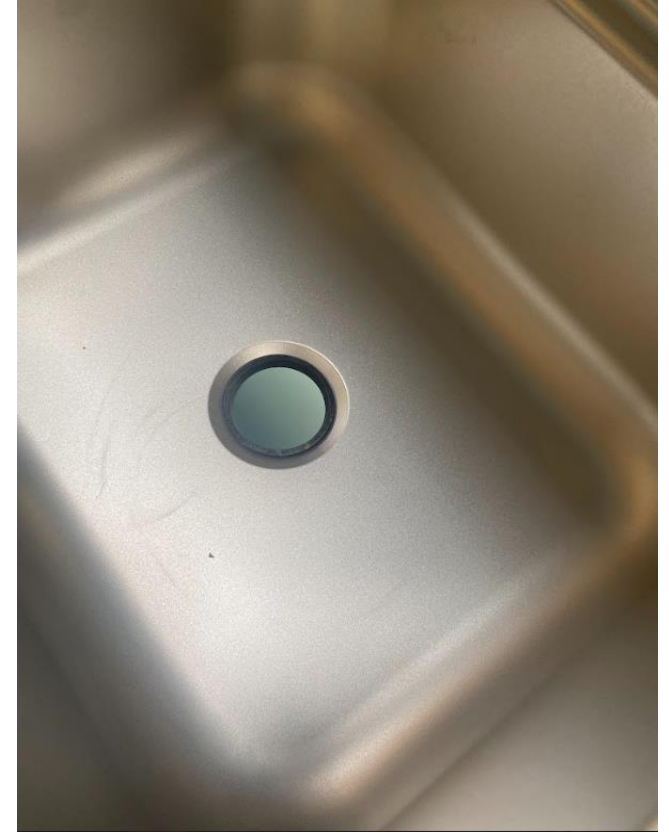

Fit the plug rubber seal

# SINK/ GRILL COMBO



Screw the drain into place

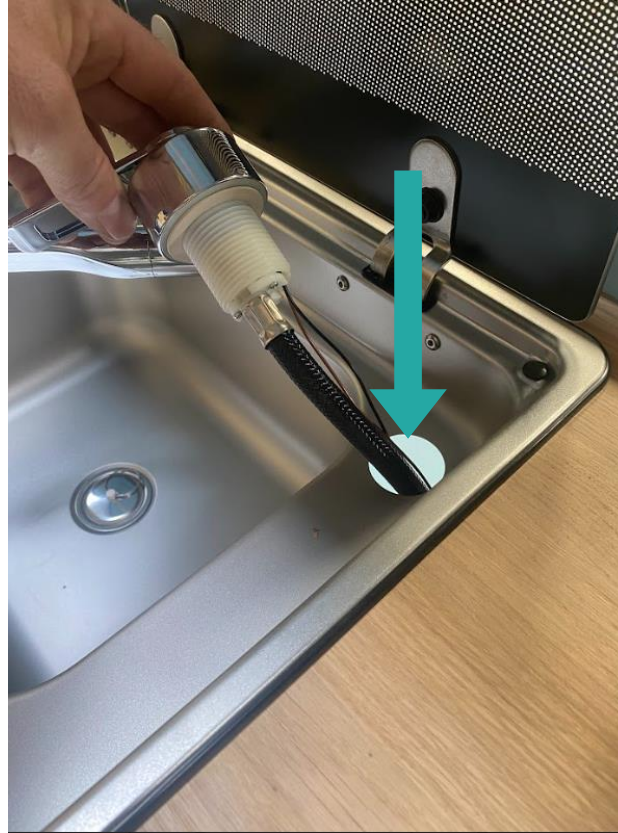

Feed the tap through the tap hole



Feed the rubber seal then fixing thread over the water pipe and cables from behind and tighten

# SINK/ GRILL COMBO



Heat one end of the freshwater pipe in hot water



Manipulate the pipe to give a wider berth

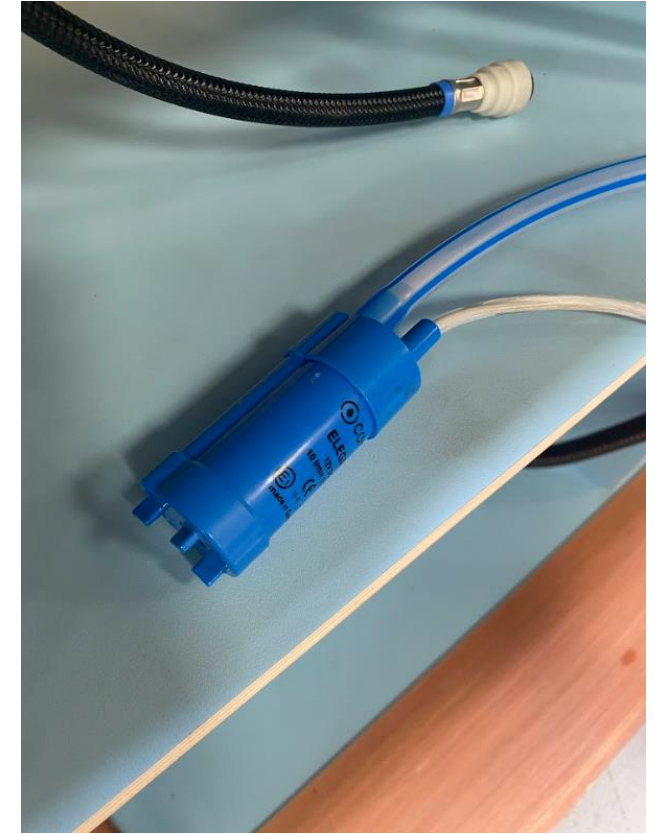

Fit the pipe to the water pump

# SINK/ GRILL COMBO



Fit the other end to the tap inlet, push firmly, there will be an obvious audio clip



Fit the 20mm waste pipe to the grey outlet under the sink, fasten with jubilee clip, heating in water may be required

# *STOP & READ*

Always use 16mm screws unless stated otherwise, failure to do so will result in screwing the furniture board

# FUSE BOARD AND MAIN LOOM



Screw the fuse board into place using the pilot holes provided

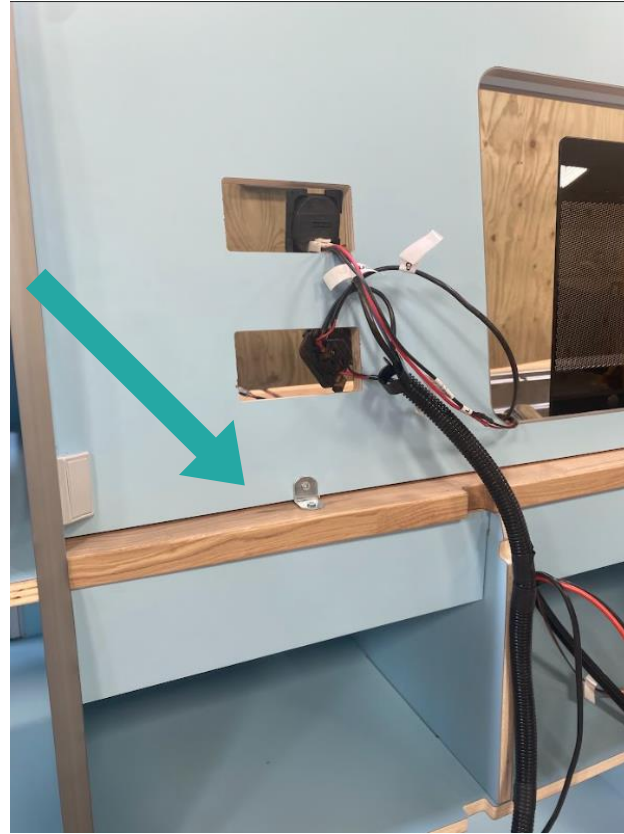

For FTC simply masking tape the switches here on the worktop, the control panel will be fitted later



Using the cut outs in the furniture, run the fridge and tap cables into place and p clip into position



# TAP WIRING DIAGRAM

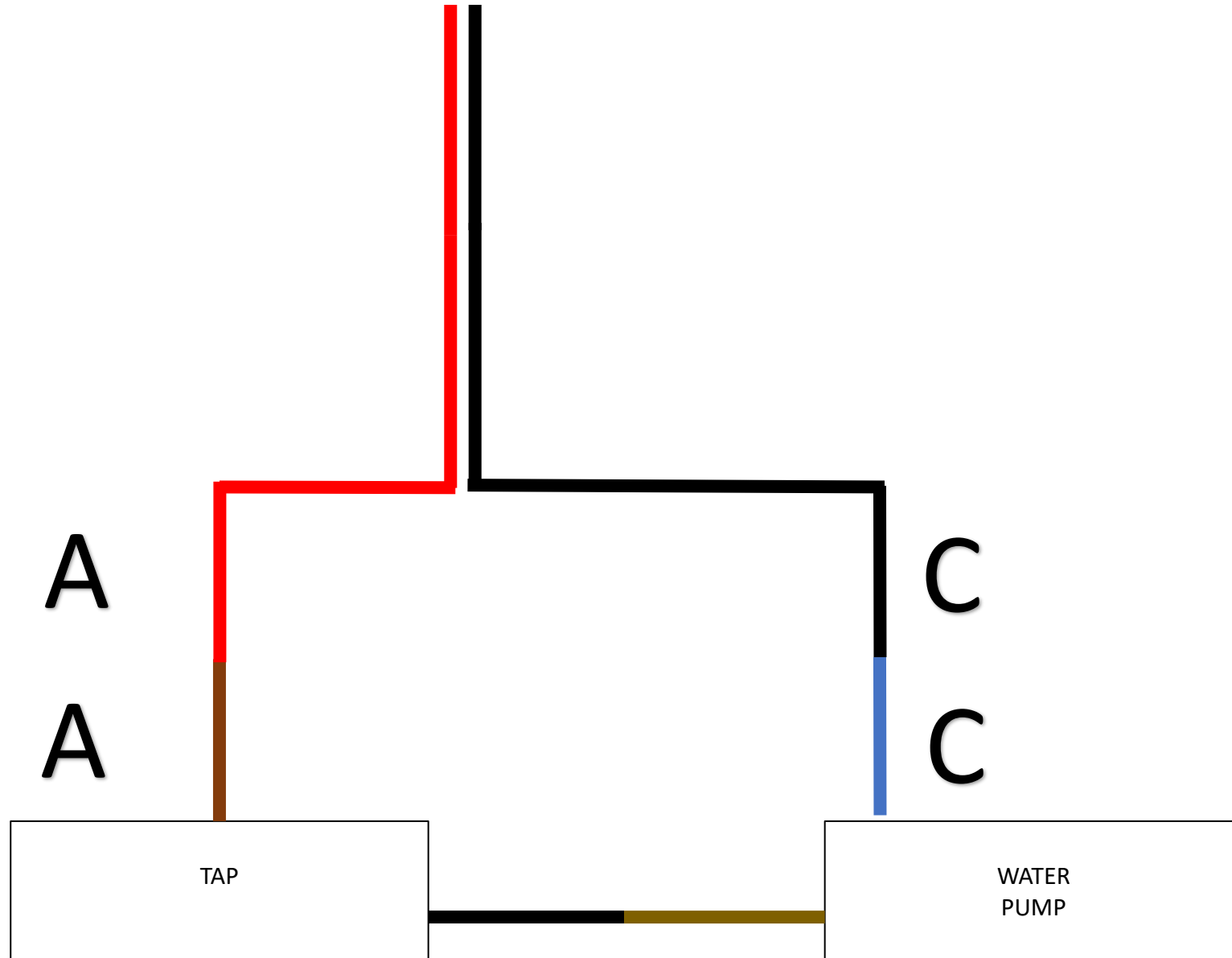

# TAP

Feed the cable and fresh pipe through the hole on the water tank lid before installation

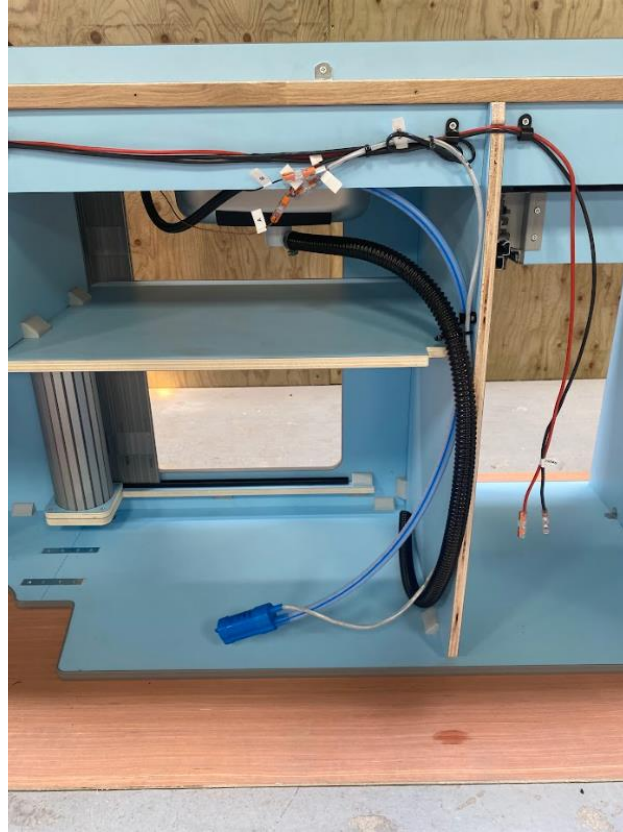
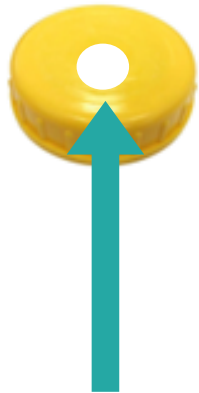

Connect the tap and water pump using the labelled wago connectors, then P-clip or cable tie away



P-clip and cable tie the waste, water pipe and tap cable into the shelf notch

# CONSUMER UNIT & SOCKET



Remove the consumer unit face and fit into position, ensure the short single 3 core blue cable and earth exits the bottom



Remove the 240 socket face and fit on the square below



Finally refit both faces

# CTEK/ BATTERY CHARGER AND TRAY



Screw the CTEK split charge into position



Screw the smart charger into position and connect



Before fitting the battery tray remember to feed the strap underneath

## BATTERY TRAY



Fit the battery tray using the pilot holes provided, have the cut-out entry point over the positive side

## WARDROBE LED



Clip the Wardrobe LED into the Qijie joiner, ensure the fit is correct

# *P-CLIP CABLE TIDY*

Tidy up all wires and P-clip into place, it's important to have tidy and organised cables, here are a few pictures of how we do it.  
Where possible clip AC, DC and water separate

# P-CLIP CABLE TIDY

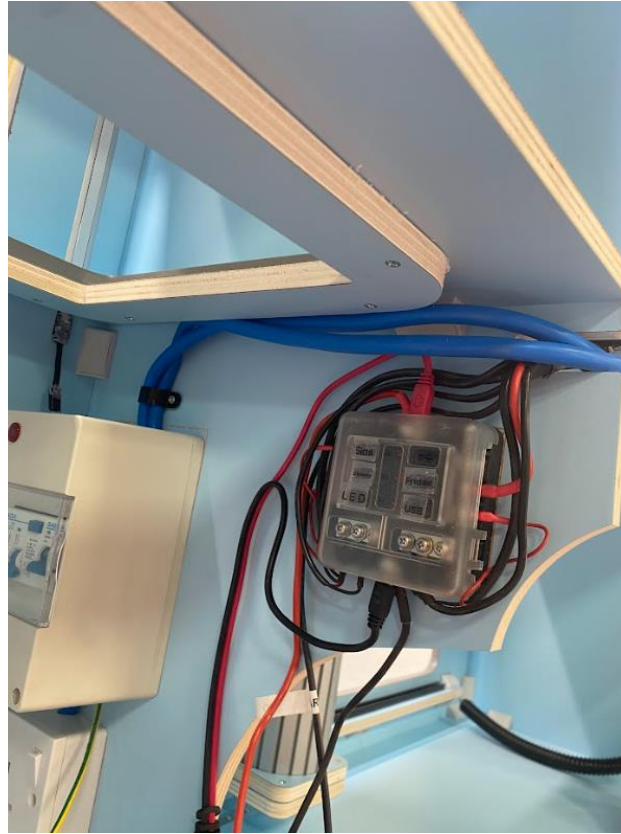

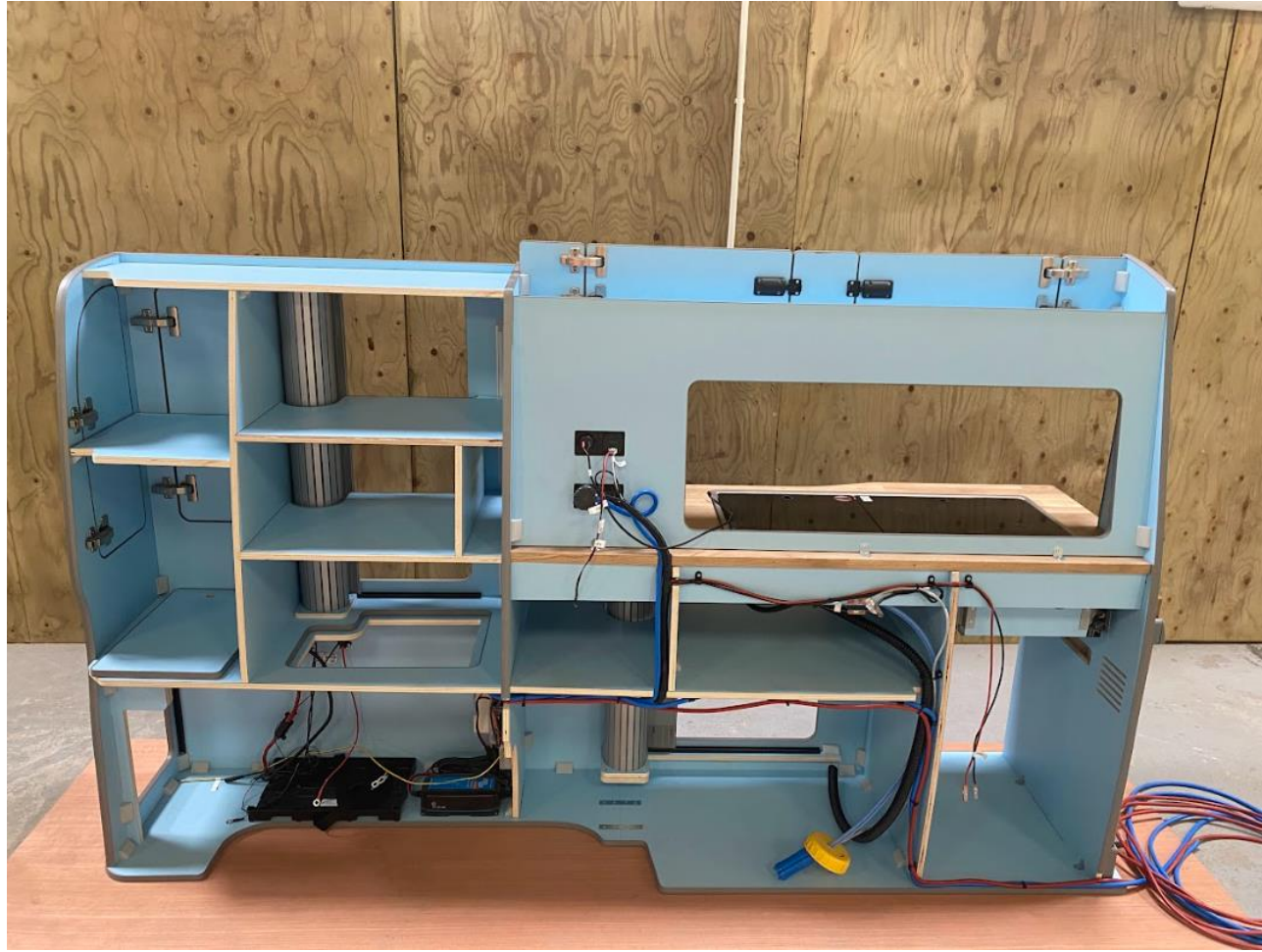



# CONNECTING THE LEISURE BATTERY



Attach the battery terminals



Fit the battery to the stary and  
secure with the strap

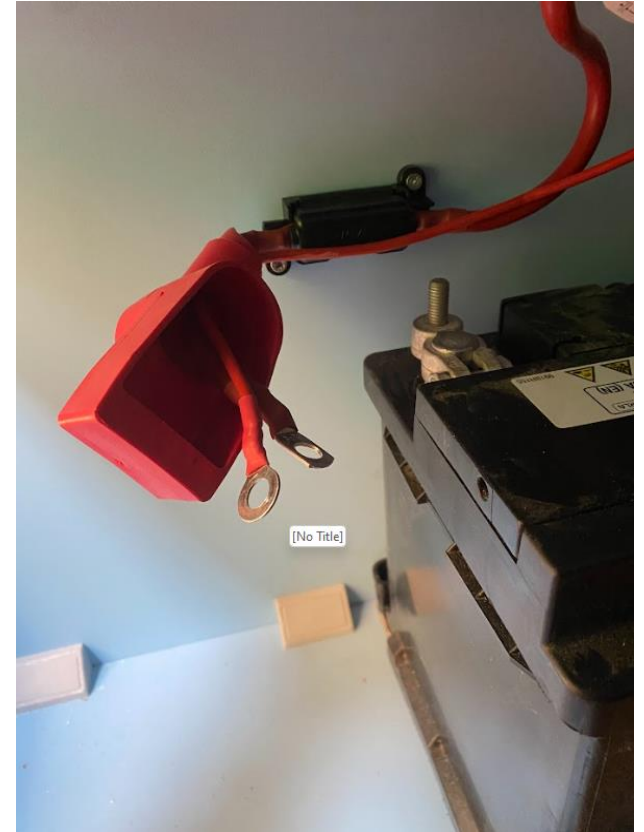

Pull all live red cables and the  
CTEK thermometer through  
the rubber terminal

# CONNECTING THE LEISURE BATTERY

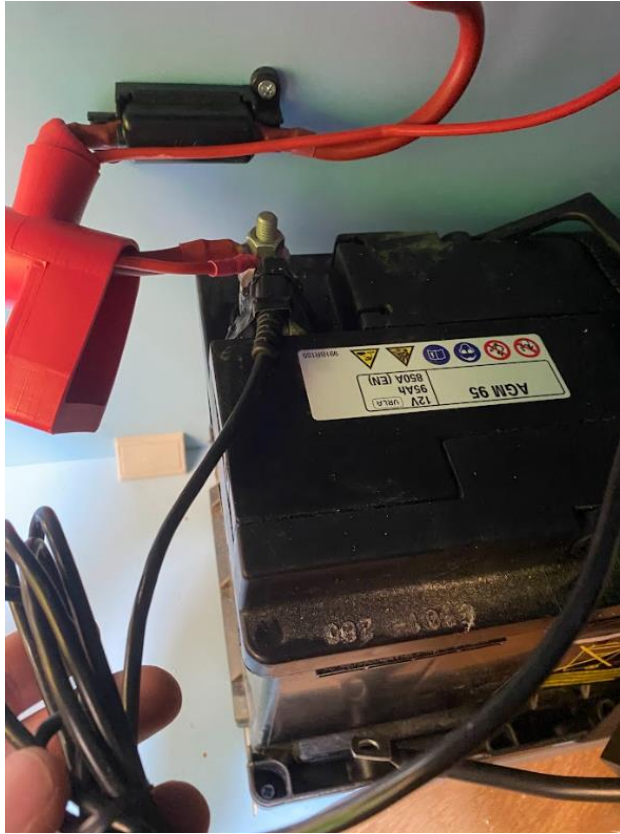

Fit the studs over the terminal positive, then firmly tape the thermometer to the terminal



Fit the rubber terminal and repeat the process for the negative, include the black earth cable

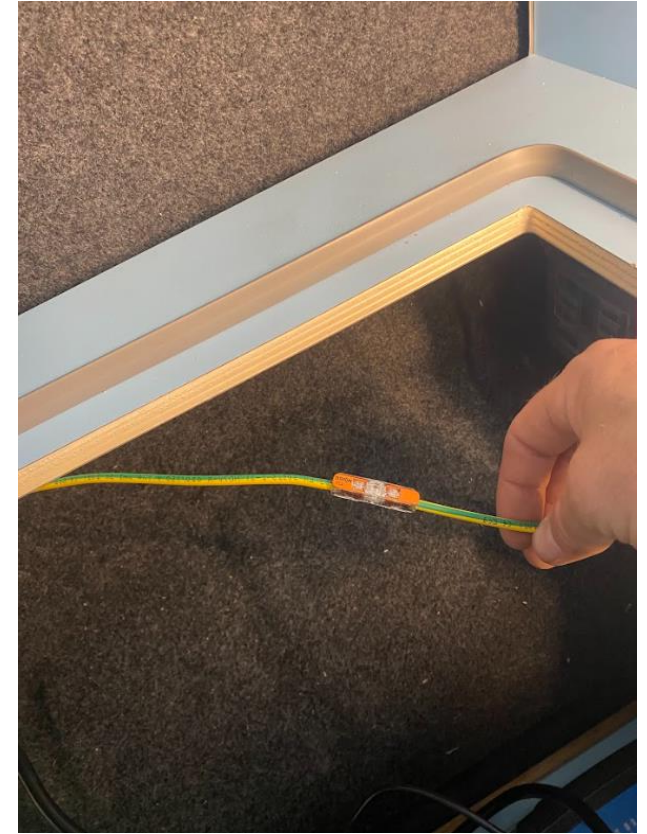

Attach the consumer unit earth with the wago clip



Offer the units into position but do not fit into place

# CONNECTING TO THE VEHICLE BATTERY



Locate and access the vehicle battery beneath the driver's seat



Connect the red split charge cable stud to the vehicle battery live



Reattach the battery cover and p-clip cables neatly

# SMART ALTERNATOR

From 2015 the customs are fitted with variable voltage charging systems that help to reduce emissions, this means conventional VSR relays are no longer appropriate to use. If you have this smart alternator, you will have a third 1mm red cable with a 'piggyback fuse' on the end that will need to be connected to a switch live/ignition feed. This can be achieved by locating the fuse box found under the steering wheel/ above the panels, simply route the cable under the trims, and plug the piggyback fuse into an ignition live.

See video links below for helpful tips

<https://www.youtube.com/watch?v=Nkb0nSuRQxE>

<https://www.youtube.com/watch?app=desktop&v=a1yoS5WfBF8>

# SMART ALTERNATOR



# FITTING THE 240 PLUG



Locate the position you want the plug and cut the excess cable according



We recommend simply fitting on the B pillar (see next slide before fitting)



If fitting inside we also recommend wind deflectors, allowing the extension to feed through the window when hooked up. These are good for air flow also

# FITTING THE 240 PLUG



Wire the 3 core artic 240 cable to the hook up

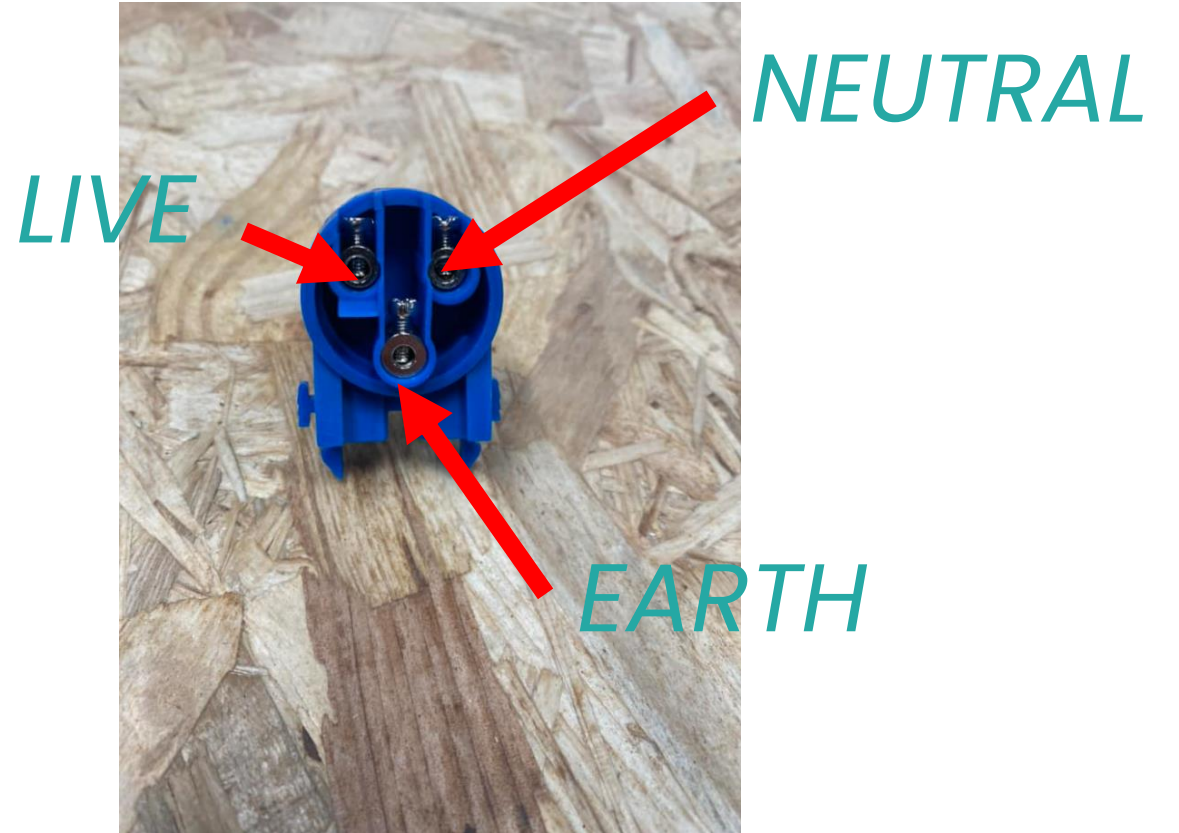

Please double check terminals match the picture as newer designs may differ



# *FITTING THE 240 PLUG*



Alternative methods include passing the cable through the fire wall and mounting under the bonnet, or fitting externally.

# *TEST*

Before securing the units to the van, we advise running an electrical test. Check all components are working correctly. Make sure your consumer unit is on with the breakers in the off position.

# FITTING THE UNITS

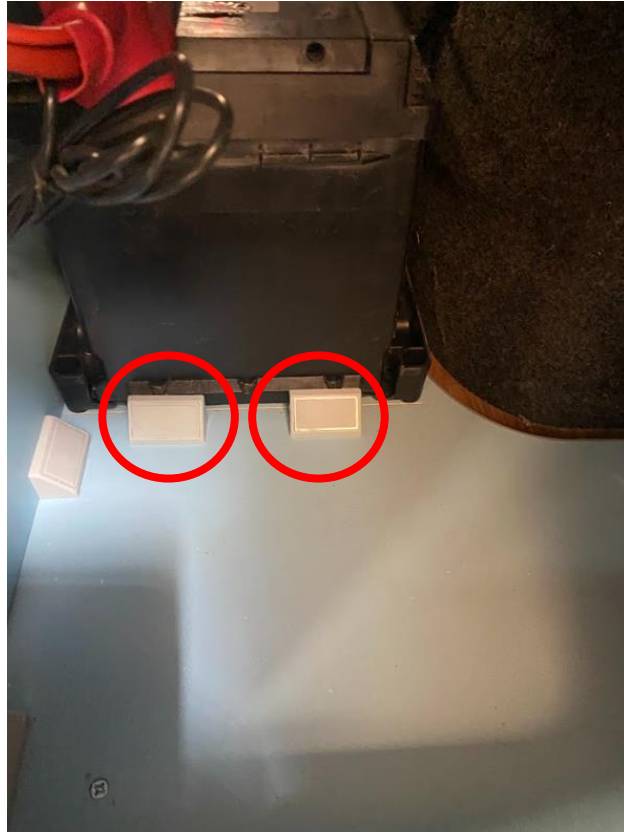

Secure the battery rear with 2 x chock blocks, screw into the base only with 16mm screws



Firstly, fit the rear into position, you will need to pilot drill through the van metal work before fixing, 16mm screws is surfiest



Repeat the process with two chock blocks as seen in the picture

# FITTING THE UNITS



Continue to secure the units to the van ply lining, 16mm screws only into the furniture, however 25mm can be more effective into the ply.



Ensure the units are pushed back and as flush as possible. Key tip, attach the block to the unit first, then into the ply

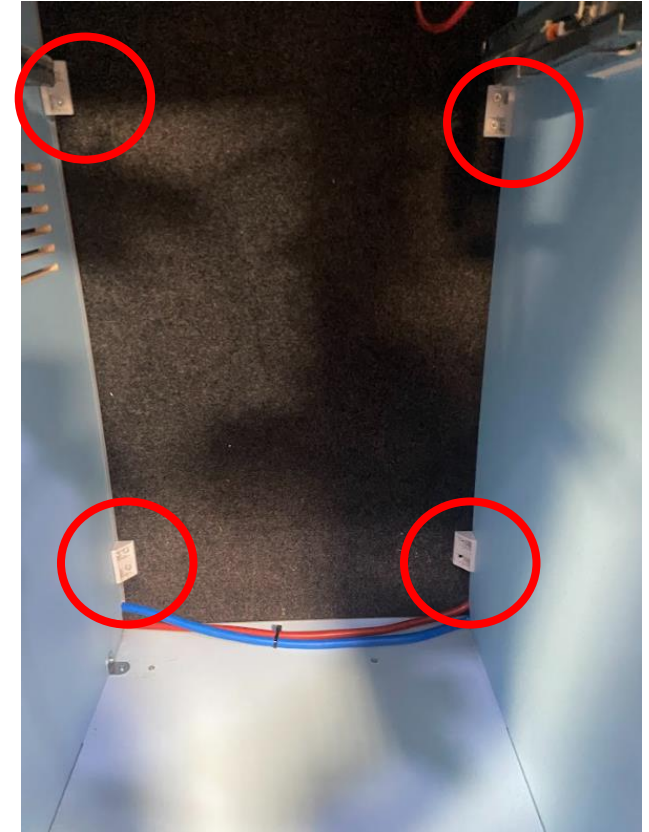

Finally, the fridge pod area, remove the drawer for easier access

# FITTING THE UNITS

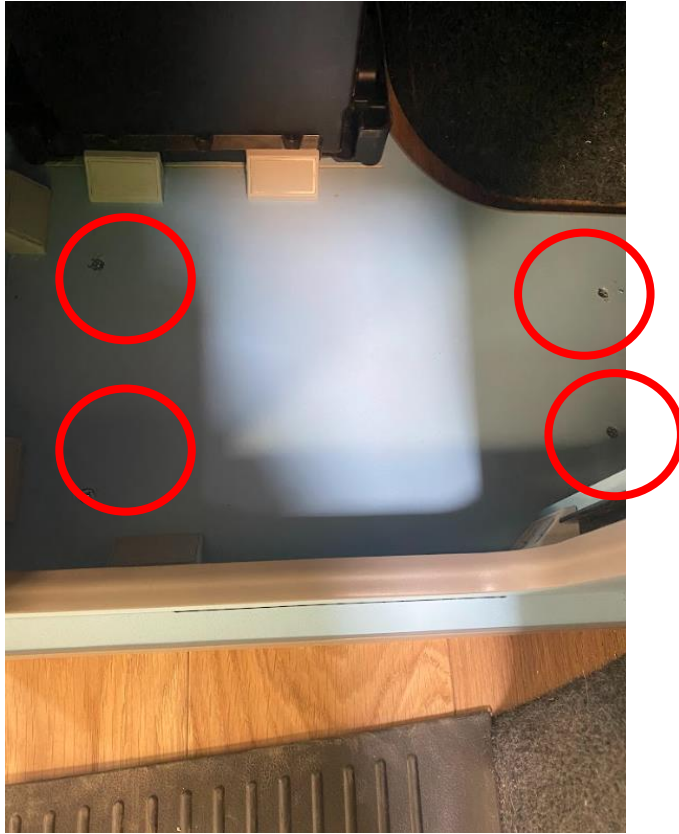

Now screw into the floor using 25mm screws.



Remove the battery access flap in the rear wardrobe to locate the two pilot holes, be mindful of the electrics

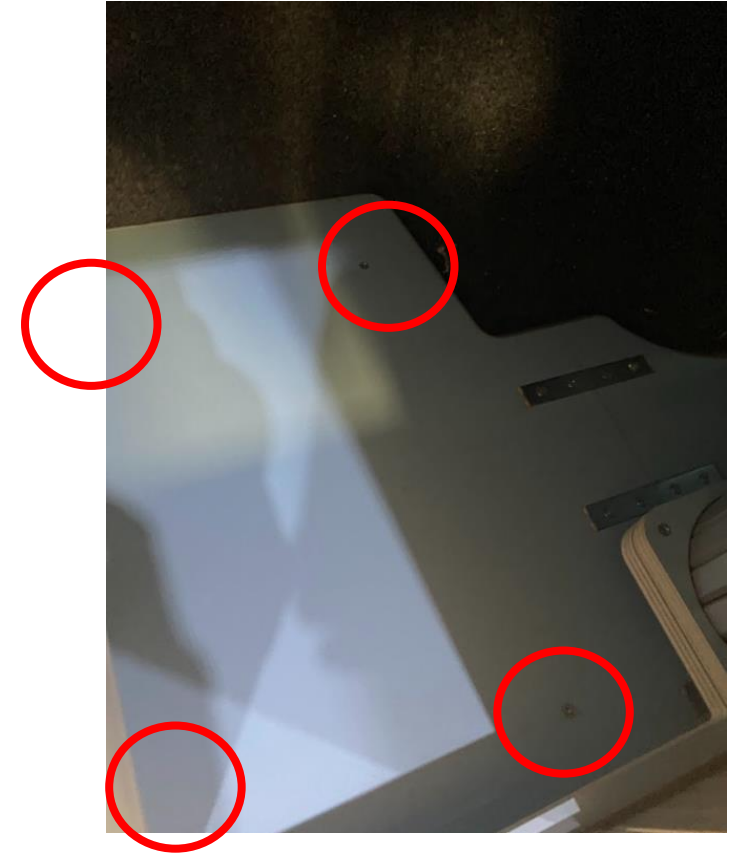

Continue in the main compartment.

# FITTING THE UNITS

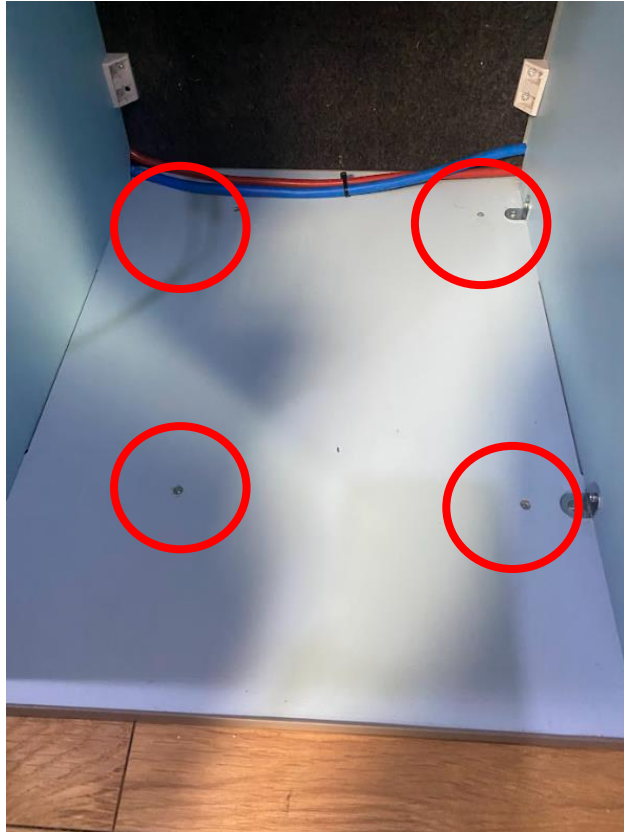

Finally, the fridge aperture .

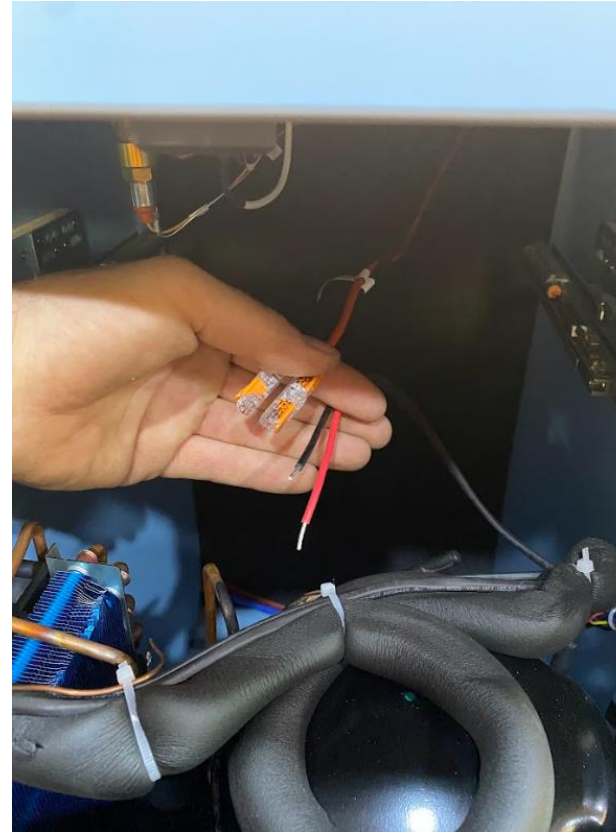

Offer the fridge into position and connect the feeds using the wago connectors, check the fridge is working before fixing



Remove the fridge fixing point caps, screw through into the aperture, use 30mm screws, be mindful not to screw through the ply

# SPLASH BACK



Once you have installed and fitted your units, offer your splash back to the recess of the van, you can fit by screwing through the splashback into the ply lining where the top locker will sit. You will also need to attach to the worktop, we advise marking exactly where it sits and screwing from the underside of the worktop to attach.

# TOP LOCKER & CONTROL PANEL



Once the splash back is in place, you can hang the top locker, please note the end panels may need scribing to suit. If you have a pop top you can hang by screwing directly into the metal work, if you have a low roof, you can hang from the headliner, please just ensure your headliner is secure, we also recommend adding some ply blocks in behind to give your screws some bite.



# C-LINE CONTROL PANEL



Remove the back cover of the 240 C-line socket

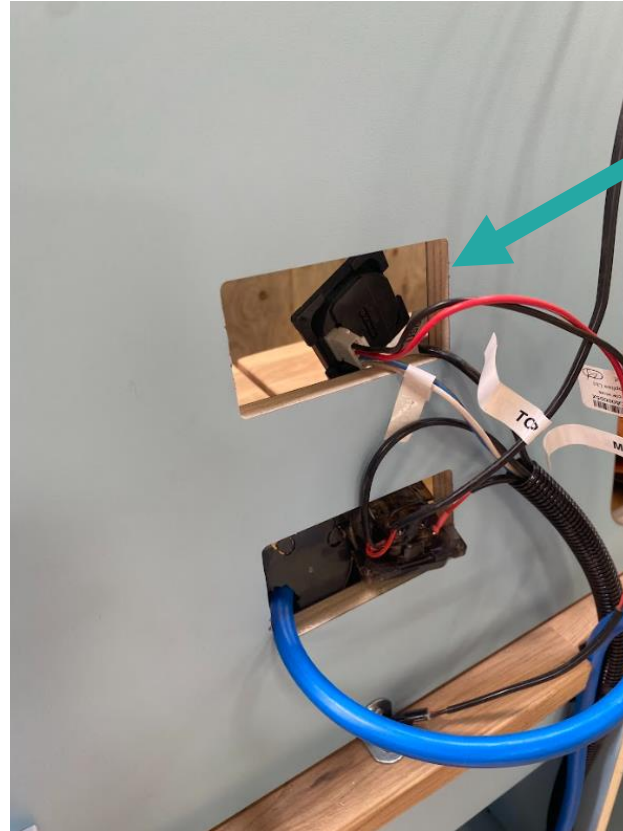

Finally fit the control panel box, this is over sized due to different variations in roof heights and will need trimming to suit for a perfect fit.

Trim from the base on both pieces

Ensure to feed all controls through the C-line cut outs before fixing

# C-LINE CONTROL PANEL



Re attach the back cover of the 240 C-line socket



Clip the controls into the fixing plate then screw into place aligning with the pilot holes provided

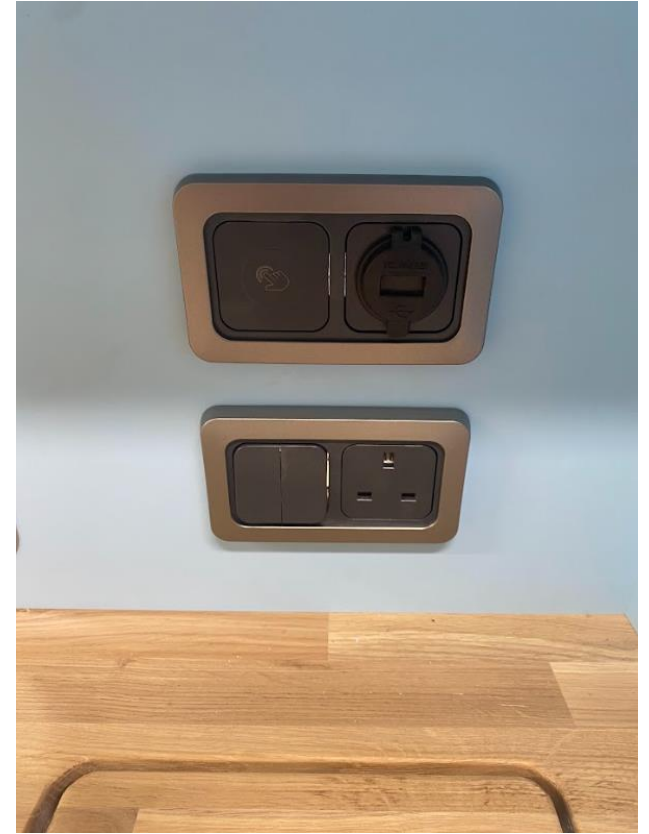

Clip the finishing cover plates over the top into position

# *FITTING THE TABLE LEG AND RAIL*



# FITTING THE TABLE LEG AND RAIL



Screw the table leg into the underside of the table with 4 x 20mm screws provided, ensure central



Fit the rail brackets 40mm from the table edge with 4 x 16mm screws in each bracket



Align the rail central and 30mm from the unit top

# FITTING THE TABLE LEG AND RAIL

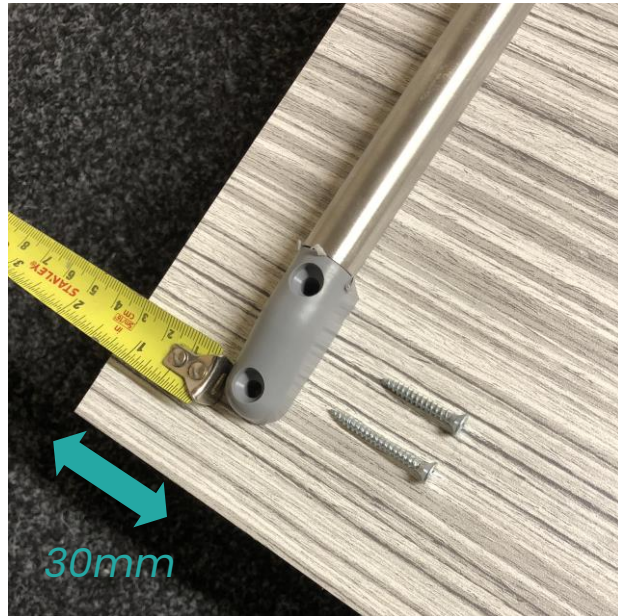

Rail 30mm from top of unit face

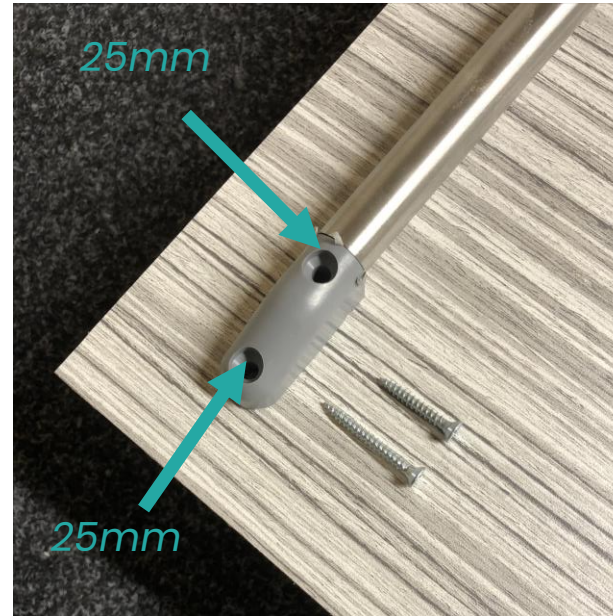

Fit the rail using a 25mm screws

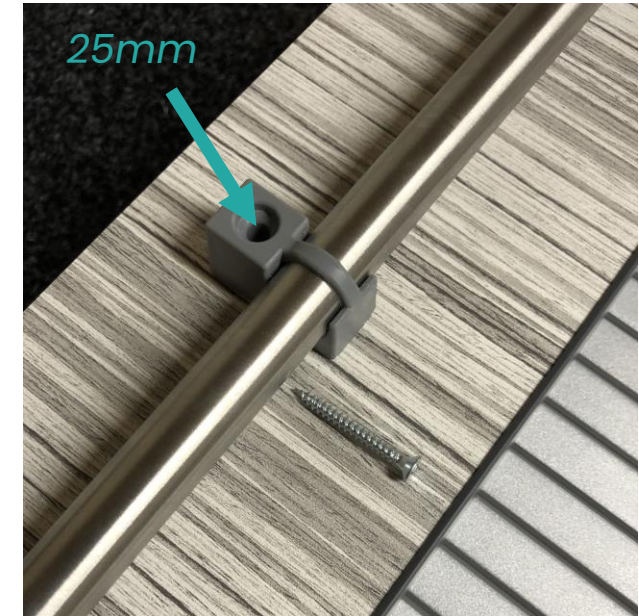

Fit the center support using a 25mm screw

# TABLE STOWAGE



Offer the table in and fit the left side storage holder, ensure its not too tight



Now fit the stowage clips using 30mm screws



**COOLWHIP**  
CAMPER CONVERSIONS

## *FIND US*

Unit 2B  
Gallows Park  
Millbrook PL11 3AX

## *CONTACT*

01752 42364  
[info@coolwhipcampers.co.uk](mailto:info@coolwhipcampers.co.uk)  
[coolwhipcampers.co.uk](http://coolwhipcampers.co.uk)

## *INFO*

Mon - Sat  
9am - 5pm  
Sunday closed